



  
ENGLISH

**TRACTOR RANGE**

  
**McCORMICK**  
Power Technology.



## CLEVER CAB: YOUR NEW OFFICE IN FIRST CLASS

Our new **Clever Cab** welcomes you on board of McCormick high-power tractors. Beautiful, spacious, quiet and functional, the **Clever Cab** offers a working environment where every detail is cared for with passion to give you unmatched performance.





HIGH-GRADE  
AUTOMOTIVE-STYLE  
FIT AND FINISH

SWIVEL SEAT WITH  
BACKREST HEATING  
AND VENTILATION

ELECTRICALLY  
ADJUSTABLE  
DASHBOARD AND  
STEERING WHEEL

### Visibility

- › The innovative Clever Cab features a four-post design with 14 percent more of glazed surface and a rear hinged door for all-round visibility.
- › The 210-degree windscreen wiper and the 75-degree opening rear window with new, bigger and more comfortable handles further improve visibility.
- › The Clever Cab features new, bigger telescopic and heated rear-view mirrors that can be adjusted from the driving position. The wide-angle mirrors allow a better view of blind spots.

### Comfort

- › The electrohydraulic semi-active cab suspension system reduces vibrations and improves stability, including on rough terrain.
- › Wide, well-spaced steps, daytime running lights integrated into the new headlamps and a hide-away buddy seat make access to the cab safe and easy.
- › The cab interior offers more room in every direction with 8 cm extra space for the head, providing additional comfort for tall operators.
- › A high-grade sound insulation system allows a noise level of only 68 dB. This low sound level is achieved through an accurate cab design: the frame is constructed using robotic welding; the engine, transmission and hydraulic system are perfectly sound insulated; cable passages are sealed to stop dust and noise from entering the cab.

- › The cab interior features an automotive-style fit and finish with easy-clean soft-touch materials.
- › The Alcantara upholstered swivel seat with dynamic air suspension system, fully automatic height adjustment and backrest heating and ventilation ensures ultimate driving comfort whatever the outdoor conditions. The headrest can be adjusted to improve the operator's vision and the armrest moves together with the seat for maximum comfort of operation.
- › The steering wheel and the dashboard are electrically adjustable in tilt and depth to suit the operator's needs. The electronically controlled steering system makes driving easier and improves working accuracy and comfort, resulting in greater productivity.
- › The multifunctional armrest can be ergonomically adjusted to suit the individual user's needs.
- › The transparent roof hatch can be opened to provide extra visibility during work.



+8CM  
HIGHER  
CAB

+14%  
LARGER  
GLASS  
AREA



-6°C  
HIGH  
HEAT  
COMFORT

68dB  
EFFICIENT  
SOUND  
INSULATION

210°  
LARGE  
WIPER  
FIELD



DSM

### Controls

- ▶ The new multifunction armrest houses all the main controls for intuitive and comfortable tractor operation. The other controls are logically and ergonomically grouped together on the right-hand console.
- ▶ The EasyPilot joystick has an ergonomic grip and features clear, easily configurable functions.
- ▶ The DSM Plus configuration offers high performance: 12-inch high-resolution, Full HD display with intuitive screens for a clear view of data and for easier and more efficient work management; intuitive 12-inch digital dashboard, controllable from the slider on the multifunctional armrest, for an unparalleled driving and working experience that further enhances productivity; advanced configuration of remote valves; full AEF ISOBUS compatibility; control of the Precision Steering Management system, our satellite-based precision guidance system.

### Accessories

- ▶ Available accessories include: 8.6L refrigerated compartment, in-cab storage compartment, bottle holder, 12 V sockets for charging mobile devices, internal mirror.
- ▶ Powerful Alpine touchscreen radio with DAB+, 4 Alpine 200 Watt RMS speakers, Android Auto and Apple CarPlay, Bluetooth, integrated microphone, and 2 USB ports.

### Climate control

- ▶ The efficient automatic climate control system features nine vents arranged in such a way as to provide 360-degree air distribution, creating an ideal working environment in all weather conditions.
- ▶ The **Clever Cab** adopts a technologically innovative glazing. The Comfort Sky coating, developed by Saint Gobain, improves UV protection and increases resistance to temperature rise within the cab, resulting in a reduction of 6 degrees Celsius compared to ordinary glass.



DSM Plus



# 12

FULL-LED  
WORK  
LIGHTS

### Lighting

Completely restyled, the twelve Full LED work lights of the Clever Cab provide optimum lighting at night and in low light conditions. The new, tilt-adjustable work lights illuminate the entire work area with a daylight-like, high-contrast light beam. Located at the rear of the cab, two long-range lights illuminate the implement end to ensure safe operation. In addition, the MyLights function allows two different light configurations for optimal lighting when working beside threshers or other similar machines.

### Cab Suspension System

To make the farmer's work less tiring, McCormick has developed Cab Suspension, a new electrohydraulic semi-active cab suspension system which isolates the tractor body from wheel vibrations induced by uneven ground conditions. Cab Suspension increases tractor stability on all terrains, enhancing ride comfort.





### Large driver's seat for cutting-edge comfort

Inspired by the automotive design, the large driver's seat is upholstered in Alcantara fabric and equipped with air suspension, automatic height adjustment, heating and ventilation. A filter system keeps the surface dry at all times for pleasant seating in all weather conditions. The headrest can be tilted to provide a better view of the work area, and the armrest moves together with the seat for full operating comfort. The seat rotates 30 degrees to the right and 10 degrees to the left, making work easier. Passengers can also travel in comfort thanks to an innovative buddy seat with a higher backrest and larger seat which neatly folds away to allow easier and safer access to the cab.



### Multifunction armrest: the right hand of efficiency

Designed from a careful analysis of the work sequences, McCormick's new ergonomic multifunction armrest groups together all the main controls in a logical manner to allow intuitive and comfortable tractor operation. Less frequently used controls are located on the right-hand console, which also houses two 12V sockets and one ISOBUS connection. Button-controlled functions can be automated and replicated on the EasyPilot joystick to allow customised operation.

### Convenient, dedicated storage compartments

Objects, telephones, food, bottles and glasses can be conveniently placed in dedicated compartments in the Clever Cab, just like in an office. All compartments are built in, so as not to obstruct the operating space, and some of them can be opened. The refrigerated compartment has a capacity of 8.6 litres.



### Easy and safe cab access

Wide, well-spaced steps, large doors and a fold-away buddy seat make access to the cab easy and safe. In addition, the daytime running lights integrated into the new headlamps and the delayed light switch off ensure safe entry and exit at night.

## CLEVER CAB, A NEW GEOMETRY OF SPACE

The new **Clever Cab** offers more space for the operator. The clever four-post design has increased the glazed area by 14 per cent to allow full view of the implements during work and of the entire working area. Interior space has also been increased, particularly in the area around the chest and head of the driver, with 8 cm extra height. The seat travel has been extended by 12 cm towards the rear side. Storage areas are all built in to keep the working space uncluttered.



**EFFICIENT AND CONVENIENT AUTOMATIC CLIMATE CONTROL**

The efficient automatic climate control system, integrated in the cab roof, allows the user to choose the desired temperature. Nine carefully arranged vents distributes the air evenly within the cab, creating an ideal working environment whatever the outdoor weather conditions. This system offers a number of advantages: the climate control adjustment button is conveniently located in front of the driver; the system is designed to reduce airflow noise; and lastly, the filters are easy to clean and positioned so as to minimise soiling.



**7-INCH MULTIMEDIA RADIO WITH DAB+**

The Alpine multimedia radio, with its high-resolution 7-inch touchscreen, is a true concentrate of technological innovation:

- › **DAB+:** In addition to offering exceptional noise-free sound, the DAB+ radio system offers a much wider choice of radio stations compared to FM radio and allows the user to easily select channels from an alphabetical or genre list of stations.
- › **Apps:** The Alpine radio system offers a number of apps with advanced functions, such as real-time traffic information, compatible with Apple Car-Play or Android Auto.
- › **Bluetooth:** Allows driver to make hands-free phone calls while working and to stream music through the Clever Cab's speakers.
- › **Sound:** The high-end 200 W RMS four-speaker sound system delivers powerful, clean and detailed sound across the entire frequency range, from deep bass to high treble.



# A RANGE OF TRACTORS TO SUIT EVERY NEED

## OPEN FIELD TRACTORS

X8 VT-DRIVE	16
X7.6	18
X7 SWB	20
X6.6	22
X6.4	24

## UTILITY TRACTORS

X6	28
X5	30
X5.085	32
X4	34

## CRAWLER TRACTORS

X4T	38
-----	----

## SPECIALTY TRACTORS

X5 HC	42
X4F CAB	44
X4F PLAT	46
X3	48
X2	50



## McCORMICK OPEN FIELD TRACTORS: BEST-IN-CLASS TECHNOLOGY

### Future

For farmers looking for cutting-edge technology, real power and uncompromising performance, McCormick open field tractors are a leap into the future. These tractors are powerful because they use all the horsepower available from the engine. And they are also technologically advanced, as they feature state-of-the-art solutions that deliver best-in-class performance. Rugged, reliable, precise and comfortable, McCormick open field tractors are trusted partners that will ensure maximum productivity in the field.

### Comfort

The cab of the McCormick open field tractors is designed to meet the highest operating and driving standards. The interior features a high-quality automotive-grade fit and finish, the dashboard and the steering column are adjustable in height and tilt, the driver's seat is designed to offer maximum comfort under all operating conditions, and the climate control system maintains optimal temperature inside the cab all year round. Based on advanced ergonomic studies, all controls are logically arranged and intuitive to use for maximum convenience and ease of operation. Built to deliver outstanding comfort and total reliability, McCormick tractors allow users to be up and running in no time, helping farmers minimise downtime and maximise their productivity.

### Customization

McCormick places the needs of modern agriculture at the core of design. At McCormick, they know that different farms have different needs, so every farm requires custom-built farm machinery. McCormick open field tractors are highly configurable so as to offer every farmer only what they need, thereby eliminating unnecessary costs. Choosing McCormick means having useful and intuitive cutting-edge technologies at your fingertips. A tailor-made equipment package that will meet your requirements while improving field operations.



# McCORMICK X8 VT-DRIVE, TECHNOLOGY AT FULL THROTTLE



## HIGHLIGHTS

- › New Clever Cab: 4-post design, glass surface increased by 14%, semi-active suspension.
- › More all-round working space and maximum ergonomic comfort.
- › Air-suspended swivel seat with heating and ventilation system. Adjustable headrest and armrest integral with seat.
- › FPT NEF 67 engine located within a cast-iron chassis for improved performance.
- › eVGT electronically-controlled variable-geometry turbocharger.
- › Stage V emissions control technology with HI-eSCR2 system and DOC catalyst
- › VT-Drive 4-stage continuously variable transmission.
- › Centre-pivot front suspended axle wet multidisc brakes.
- › CCLS hydraulic system with variable-displacement pump with up to 212 l/min flow.
- › Best in Class system: 1000-hour maintenance intervals to save time and costs.
- › Coolers open out to allow easier and faster cleaning.
- › ISOBUS & PSM Precision Steering Management.
- › McCormick Farm and McCormick Farm Fleet & Remote Diagnostics Management systems for efficient management of your farm and tractor fleet.

The innovative **X8** tractor from McCormick is designed to cater for the most demanding needs of large farms and agricultural contractors. The Clever cab offers a roomy interior with a generous glazed surface and a highly efficient sound insulation. The cab is equipped with: high-grade fit and finish; ventilated air suspension swivel seat; adjustable steering wheel and instrument panel; multifunction armrest and multifunction joystick; 12" touch screen monitor; powerful Alpine touch radio with DAB+, Auto Android and Apple CarPlay; automatic climate control. The semi-active cab suspension system reduces noise and vibrations levels within the cab, while the suspended front axle absorbs impacts from rough ground. The cab features up to 20 next-generation LED work lights fitted on the bonnet, cab and fenders for optimal illumination of the work area during night-time operation. Two rear view cameras give the driver unobstructed visibility behind the vehicle. The **X8** is powered by an FPT NEF 67 6.7-litre, 24-valve, 6-cylinder engine with turbocharger and common rail injection system that delivers up to 313 hp and meet Stage V emission regulations. The engine is located within a rugged cast-iron chassis and suspended on silent blocks; this reduces vibrations within the cab and enables maximum power transfer to the ground for improved tractor performance. The **X8** is equipped with the innovative VT-Drive four-stage continuously variable transmission. A high-flow hydraulic system provides a maximum total flow of 212 l/min and supplies 140 l/min to operate up to eleven electrohydraulic remotes.

### SEMI-ACTIVE CAB SUSPENSION

Cab Suspension, the innovative semi-active cab suspension system from McCormick, isolates the tractor body from wheel vibrations induced by uneven ground conditions, ensuring comfort and safety on all terrains. The semi-active cab suspension can be specified with three different shock absorbing levels for easier tractor management and enhanced operator comfort.



### VT-DRIVE FOUR-STAGE TRANSMISSION

The VT-Drive four-stage continuously variable transmission steps into the future with a technology capable of increasing speed ranges from two to four. This provides real benefits in terms of fast acceleration, smooth driving, fuel economy and efficiency.

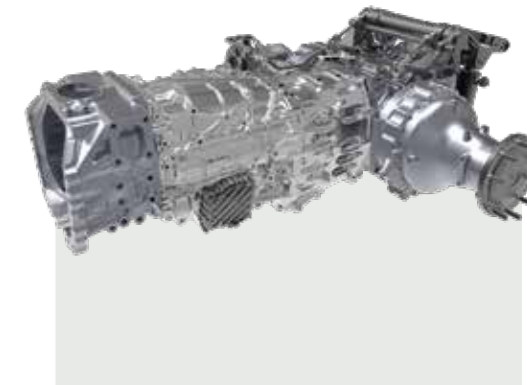

### McCORMICK DIGITAL SOLUTIONS

McCormick digital solutions for the **X8** include ADS+ and satellite-based guidance for maximum accuracy and ease of operation; ISOBUS system for efficient implement control; Fleet & Remote Diagnostics Management for monitoring the fleet, analysing the tractor data and performing diagnostics remotely; McCormick Farm for efficient farm management.



# McCORMICK X7.6, EFFICIENCY AT ITS VERY BEST



The X7.6 LWB range leads the open field tractor market for efficiency, performance, flexibility and comfort. The Clever cab offers a more spacious and better sound-insulated work environment with a more generous glazing. Interior cab features include an automotive-style fit and finish; ventilated air suspension swivel seat; adjustable steering wheel and instrument panel; multifunction joystick; 12" touch screen monitor; powerful Alpine touch radio with DAB+, Auto Android and Apple CarPlay; automatic climate control; transparent roof hatch and up to 10 LED lights for full all-round visibility. In addition, a semi-active cab suspension system absorbs vibrations caused by uneven ground, while reducing in-cab noise. The front axle suspension further dampens impacts on rough ground, maximising the ride comfort. The X7.6 LWB is powered by FPT NEF 67 engines with up to 240 hp located within a rugged chassis with shock absorbing rubber mounts which reduces shocks and vibrations, while improving tractive performance. The X7.6 tractors come with a choice of two transmissions: a VT-Drive four-stage continuously variable transmission with four planetary gear trains, and a P6-Drive transmission with five ranges and a six-speed on-the-go PowerShift providing 30 F + 15 REV speeds. A creep speed option increases speeds up to 54 F and 27 REV. The hydraulic system features a high-flow pump that provides a total flow of 160 l/min ensuring efficient implement operation. Choosing McCormick means choosing a partner capable of providing advanced technology combined with uncompromising reliability and performance.

## HIGHLIGHTS

- › New Clever Cab: 4-post design, glass surface increased by 14%, semi-active suspension.
- › More all-round working space and maximum ergonomic comfort.
- › Air-suspended swivel seat with heating and ventilation system. Adjustable headrest and armrest integral with seat.
- › Best in Class system: 1000-hour maintenance intervals to save on time and costs.
- › Coolers open out to allow easier and faster cleaning.

### FPT NEF ENGINES: PLENTY OF PULLING POWER IN THE FIELD

The FPT NEF 6.7L, 24-valve, 6-cylinder turbo engines with common rail injection system deliver power ratings of up to 240 hp and meet Stage V emission regulations. The engines are located within a rugged chassis with shock absorbing rubber mounts which helps reduce noise and vibration levels within the cab and transfers all the power to the ground, maximising traction performance.

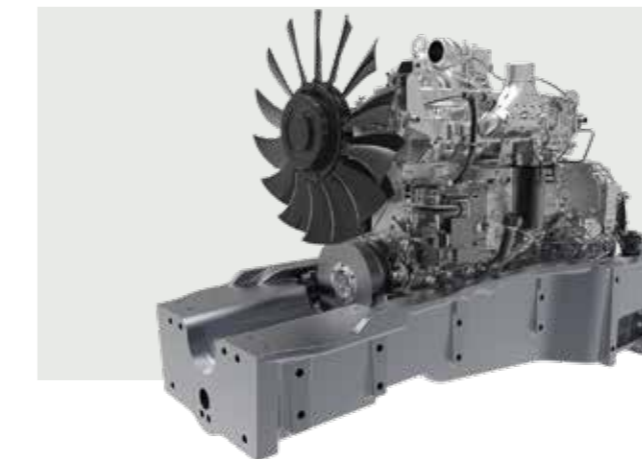

- › VT-Drive 4-stage continuously variable transmission.
- › P6-Drive transmission with 6 PowerShift speeds and 5 robotised ranges.
- › Closed-centre hydraulic system with up to 160 l/min variable displacement pump.
- › Premiere Cab with 4-post design and semi-active suspension system.
- › Front axle with independent suspension.

### VT-DRIVE AND P6-DRIVE TRANSMISSIONS

The VT-Drive four-stage continuously variable transmission delivers fast acceleration and excellent responsiveness. The P6-Drive transmission with six PowerShift speeds and five ranges provides 30F + 15 REV speeds and up to 54F + 27 REV speeds with creeper, resulting in smooth driving, high performance and optimal fuel efficiency.



- › Two trim levels: Efficient, with mechanical remote valves; Premium, with multifunction armrest and electrohydraulic remotes.
- › DSM Data Screen Manager: 12" touch screen monitor with new functions.
- › ISOBUS & PSM Precision Steering Management.
- › McCormick Farm and McCormick Fleet & Remote Diagnostics Management systems for efficient management of your farm and tractor fleet.

### McCORMICK DIGITAL SOLUTIONS

McCormick digital solutions for the X7 LWB include ADS+ and satellite-based guidance for maximum accuracy and ease of operation; ISOBUS system for efficient implement control; Fleet & Remote Diagnostics Management for monitoring the fleet, analysing the tractor data and performing diagnostics remotely; McCormick Farm for efficient farm management.



# McCORMICK X7 SWB, WHEN TECHNOLOGY TURNS INTO EFFICIENCY



Designed for farmers looking for an open-field tractor that combines powerful performance with easy manoeuvrability and superior comfort, the **X7 SWB** tractor range is powered by structural four- and six-cylinder engines. The Premiere cab offers automotive-grade fit and finish, ergonomically-arranged controls, 12" touch screen monitor with new functions and up to 12 LED lights on cab roof. The mechanical cab suspension system absorbs impacts and vibrations. The front axle with independent suspension further increases traction, safety and comfort. The newly-designed, 90-degree tilt bonnet and the radiator coolers opening from a single latch make maintenance faster and easier. This range is also available with the new Clever Cab, combining cutting-edge technology with unparalleled comfort. The **X7 SWB** tractors are powered by new Stage V FPT NEF 67 6.7-litre, 24-valve, six-cylinder engines and Stage V FPT NEF 45 4.5-litre, 16-valve, four-cylinder engines. Both models offer power ratings of up to 175 hp. The wheelbase is 2760 mm on six-cylinder tractors and 2651 mm on the four cylinders. The **X7 SWB** tractor range offers a choice of two transmissions: a VT-Drive four-stage continuously variable transmission and a P6-Drive transmission with a six-speed on-the-go PowerShift and five ranges providing 30F/15R speeds. The creeper increases the number of speeds to 54F/27R. The tractor features a four-speed PTO, a front hitch capable of lifting up to 3500 kg and an electronic rear hitch with a lift capacity of 9300 kg. The CCLS hydraulic system with its 160 l/min pump operates up to eight remote valves. The **X7 SWB** can be equipped with: EazySteer and PSM – Precision Steering Management, for maximum ease and accuracy of operation; ISOBUS system for efficient implement control; Fleet & Remote Diagnostics Management for monitoring the fleet, analysing the tractor data and performing remote diagnostics; McCormick Farm for efficient farm management.

## HIGHLIGHTS

- › New Clever Cab: +14% glazed surface; more work space; improved ergonomics; heated and ventilated swivel seat with dynamic air suspension, integral armrest and swivelling headrest.
- › Premiere Cab with mechanical suspension and mechanically-controlled remote valves.
- › Front axle with independent suspension.
- › VT-Drive four-stage continuously variable transmission.
- › P6-Drive transmission with 6 powershift speeds and 5 robotised ranges.
- › CCLS hydraulic system with variable displacement pump delivering up to 160 l/min.
- › Mechanical or electrohydraulic remote valves.
- › Data Screen Manager: 12" touch screen monitor with new functions.
- › McCormick Farm and McCormick Fleet & Remote Diagnostics Management systems for efficient management of your farm and tractor fleet.

## FPT NEF ENGINES FOR AMAZING EFFICIENCY

The **X7 SWB** tractors are powered by new Stage V FPT NEF 45 4.5-litre, 16-valve, 4 cylinder engines and Stage V FPT NEF 67 6.7-litre, 24-valve, 6 cylinder engines. All engines are turbocharged with intercooler and electronic common rail injection system and provide power ratings of up to 175 hp. The structural engine and the short wheelbase further improve tractor efficiency and manoeuvrability.



## A FLOW DIVIDER TO GIVE YOU MORE HYDRAULIC FUNCTIONS

An optional flow divider with six quick-connect couplings controls three different hydraulic functions through a flow selector using a single remote valve: with five remotes and one flow divider you can control up to seven different hydraulic functions.



## MY McCORMICK APP, ALWAYS BY YOUR SIDE

The intuitive My McCormick app offers the user a 360-degree immersive experience through our Digital Solutions. The app gives you easy access to all McCormick digital services, including news, insights and exclusive offers, to help you make your work more efficient and productive.



# McCORMICK X6.6, SIMPLY POWERFUL AND RELIABLE



## HIGHLIGHTS

- › Premiere Cab with suspension system and air-suspended seat for greater ride comfort.
- › New forward-sloping bonnet for enhanced visibility.
- › FPT NEF 67 6.7-litre engines with power ratings up to 175 hp.
- › Eco-friendly engine with Hi-eSCR2 after-treatment system to meet Stage V/Tier 4 Final emissions regulations.
- › Oversized fuel tank: 280 litres for long running times without refuelling.
- › Xtrashift transmission with 6 powershift speeds (HML) and 3 ranges for a total of 54F and 18R gears.
- › Closed-centre hydraulic system with variable-displacement pump ensuring a flow rate of 110 + 38 l/min.
- › Up to 5 rear mechanical remote valves.
- › Electronically-controlled rear hitch capable of lifting 8400 kg.

### NEW FPT ENGINE: MORE POWER, MORE EFFICIENCY

The FPT NEF 67 6.7-litre, 6-cylinder turbo intercooled engine with power rating up to 175 hp meets Stage V/Tier 4 Final emissions regulations. With up to 700 Nm torque at 1400 rpm, the engine of the X6.6 improves traction and reduces fuel consumption by 10%. A 280-litre fuel tank ensures many hours of uninterrupted operation. The tilt-up bonnet makes daily maintenance checks quick and easy.



### FRONT AXLE: TRACTION AND MANOEUVRABILITY

Equipped with differential lock, wet disc brakes and four-wheel drive, the front axle of the X6.6 is highly efficient and offers a high ground clearance and a 55-degree steering angle. These features improve traction and manoeuvrability, thereby increasing comfort, safety and productivity.



### RUGGED ELECTRONIC REAR HITCH

The electronic rear hitch category 2 and 3 ensures simple and precise implement operation. The hitch is equipped with draft control, position control, mixed control and float position. Powerful and reliable, the rear hitch of the X6.6 lifts up to 8400 kg.



Rugged and user-friendly, the X6.6 tractor is a truly reliable partner that will carry out all tasks in the field efficiently. The Premiere four-post cab with opening roof hatch and the forward-sloping bonnet provide unobstructed all-round visibility. The operator works in comfort with intuitive ergonomic controls, an air suspension seat, a telescopic steering wheel, and an efficient air conditioning system. Ten halogen work lights, 6 of which on the cab, provide powerful illumination for night work. The X6.6 tractors are powered by FPT NEF 67 6.7L, 6-cylinder turbo intercooled engines that meet Stage V/Tier 4 Final emissions regulations. With power ratings up to 175 hp, these engines deliver a torque of 700 Nm at 1400 rpm, for improved traction and 10% lower fuel consumption. A 280-litre fuel tank allows many hours of uninterrupted operation. The Xtrashift transmission with 6 powershift speeds (HML) and 3 ranges provides 54F and 18R gears. The de-clutch function and the power shuttle allow the operator to easily shift through all gears and change from forward to reverse without clutching. A creeper with 105F and 36R gears ensures speeds as low as 350 m/h. The closed-centre hydraulic system with variable-displacement pump has a total flow of 148 l/min and operates up to five mechanical remotes, an electronic rear hitch with 8400 kg lift capacity and a two-speed PTO with 540/1000 rpm. An electro-hydraulically operated wet multidisc clutch enables smooth and modulated PTO engagement. McCormick X6.6: power and simplicity without compromise.

## McCORMICK X6.4, VERSATILITY IN THE FIELD



### HIGHLIGHTS

- › FPT NEF 45 Stage V engine delivering up to 155 hp.
- › P6-Drive transmission with 6 powershift speeds and 4 ranges.
- › IFS suspended front axle and suspended cab.
- › SmartPilot all-in-one joystick controller.
- › Closed-centre hydraulic system (CCLS) with up to 114 l/min flow rate.
- › High Visibility cab with panoramic roof with see-through hatch and FOPS protection.
- › ISOBUS & PSM - Precision Steering Management.
- › McCormick Farm and McCormick Fleet & Remote Diagnostics Management systems for efficient management of your farm and tractor fleet.
- › Front hitch and PTO.
- › Max tyre size: 600/65R38. Gross vehicle weight: 9500 kg.

Designed with efficiency, versatility and comfort in mind, the X6.4 is a true do-it-all tractor that will handle a variety of tasks both in the field and around the farm. Ideal for sowing, ploughing, harrowing and haymaking, this handy tractor is equally perfect for use inside barns and stables as well as for front loader and transport operations. The High Visibility cab features a high-quality fit and finish, ergonomic controls, a SmartPilot all-in-one controller, a 12-inch touch screen monitor with new menus and 14 full-LED lights for optimum visibility in any working conditions. The independent front suspension combined with the cab suspension ensures maximum traction and ride comfort on all terrains. The newly-designed bonnet opens to 90 degrees to provide easy access to the engine compartment for fast service and maintenance and the radiator coolers open fully from a single latch to provide easy cleaning in dusty conditions.

The X6.4 tractors are powered by FPT NEF 45 4.5L, 16-valve, 4-cylinder engines that meet Stage V emissions regulations and deliver up to 155 hp. The P6-Drive transmission offers 6 powershift speeds and 4 ranges providing 24F + 24R gears. Other features include a 4-speed PTO, front hitch with 3200 kg lift capacity, electronic rear hitch with 7200 kg lift capacity, CCLS hydraulic system with a total flow of 114 l/min and up to seven remote valves. The X6.4 reduces operating costs and increases productivity and profitability thanks to advanced features such as the PSM satellite-based guidance system; ISOBUS system for efficient implement control; Fleet & Remote Diagnostics Management for monitoring the fleet, analysing the tractor data and performing diagnostics remotely and McCormick Farm for efficient farm management.

#### HIGH VISIBILITY CAB FOR ALL-ROUND VIEW

Better visibility means greater efficiency and added comfort. The High Visibility cab with see-through sunroof and FOPS protection provides unequalled all-round view for haymaking and front loader applications.



#### P6-DRIVE: NEXT-GENERATION PERFORMANCE

Designed to further enhance the tractor performance, the P6-Drive transmission offers 6 powershift speeds and 4 ranges providing 24F + 24R gears. AutoPowershift for fully automatic up- and downshifting. With additional creep speeds, the transmission provides a total of 40F + 40R gears. With the P6-Drive transmission, the tractor reaches 50 km/h at reduced engine speed.

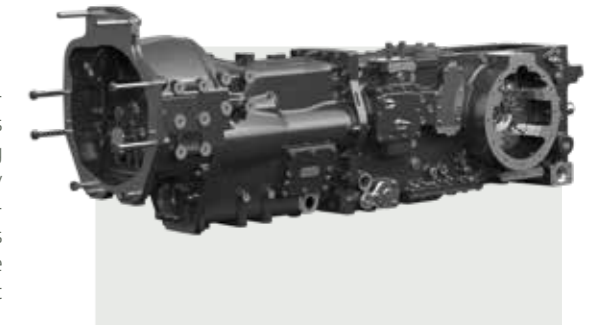

#### SMARTPILOT JOYSTICK CONTROLLER TO KEEP EVERYTHING UNDER CONTROL

Integrated into the ergonomic multifunction armrest, the innovative SmartPilot all-in-one controller provides easy and intuitive control of key tractor functions such as the powershift transmission, reverse shuttle, hydraulics, front hitch, rear hitch and front loader.



## McCORMICK UTILITY TRACTORS: SMART VERSATILITY



### Technology

Anyone who's driven one knows McCormick tractors are a worldwide benchmark for technology and performance, an industry-leading position that can only be achieved through careful design and continuous innovation. McCormick has built the same quality of its high-end tractors into the utility range. The result is a line of tractors fully loaded with the latest technology and features that will give farmers all the power and efficiency they need.

### Flexibility

McCormick utility tractors are designed and manufactured to meet the flexibility needs of modern farms. These tractors are not derived from any existing models, but have been designed from the ground up based on the innovative solutions and proven performance that are our trademark. If you are looking for a tractor that provides all the versatility and efficiency required for ploughing, harrowing, mowing, haymaking, orchard work, transport and a variety of other tasks, then look no further: a McCormick utility tractor is what you need.

### Quality

The quality of a utility tractor depends on its size. McCormick utility tractors are the ideal size. Large enough to provide the right amount of traction and stability required for open field and transport applications, yet sufficiently small to move easily between crop rows and within cattle sheds without difficult and time-consuming manoeuvres. But the quality of a utility tractor also depends on its equipment. McCormick utility tractors are fully equipped technologically advanced vehicles that will fit seamlessly into the customer's fleet. McCormick utility tractors know how to deliver uncompromising efficiency and comfort.

# X6, YOUR ALL-ROUND PARTNER



## HIGHLIGHTS

- › Iso-mounted cab and air suspension seat for enhanced driving comfort.
- › Low-profile cab roof for easy access to low farm buildings.
- › 8.4-inch tablet-like touch screen display for intuitive operation.
- › FPT F36 3.6L delivering up to 127 hp.
- › Full compliance with Stage V emissions requirements thanks to the Hi-eSCR2 system.
- › XtraShift transmission with three-speed HML Powershift.
- › Suspended front axle with brakes, full locking differential and electro-hydraulically operated four-wheel drive.
- › Closed-centre hydraulic system with 110 l/min flow rate for improved performance.
- › Rear four-speed PTO.
- › Rear hitch with 6000 kg lift capacity.
- › McCormick Farm and McCormick Fleet & Remote Diagnostics Management systems for efficient management of your farm and tractor fleet.

### XTRASHIFT TRANSMISSION FOR SUPERIOR PERFORMANCE

The Xtrashift electrohydraulic transmission incorporates a three-speed on-the-go powershift (HML) and provides 36F and 12R gears with a top speed of 50 km/h at low engine rpm. The de-clutch button and the power shuttle allow the operator to automatically shift through all gears and change from forward to reverse without depressing the clutch pedal.



### EFFICIENT FRONT HITCH FOR ENHANCED PRODUCTIVITY

Efficient and precise, the front hitch of the X6 can lift up to 2250 kg and is compatible with McCormick M30 front loaders and front PTO. A wide range of ballast weights ensures excellent tractor balance in any situation.



### SUSPENDED AXLE: TRACTION, AGILITY, COMFORT

The front axle suspension absorbs impacts caused by rough terrain, thereby enhancing ride comfort. Optimum weight distribution ensures efficient power transfer to the ground, maximising traction, agility and stability. The four-wheel drive and the differential lock engagement further improve tractor control and safety.



The X6 is a versatile utility tractor that can be used for a wide variety of tasks. Thanks to its short wheelbase, the X6 is efficient out in the field, easy to manage in the barn and safe to run on the road. The Total View Slim cab with its four-post design with either a mechanical or silent-block suspension offers excellent all-round visibility. The cab has a low-profile roof with FOPS protection for easy access to low buildings and a transparent hatch for extra visibility during loader work. A multifunctional joystick allows for easier operator control, while ten Full LED work lights provide optimal visibility in any conditions. The X6 tractors are powered by FPT F36 16-valve, 3.6-litre engines that meet Stage V emissions regulations and deliver up to 127 hp. Thanks to a maximum torque of 518 Nm at 1300 rpm, fuel consumption is reduced by 10%. The 90-degree tilting bonnet and the radiator coolers opening from a single latch make for fast and easy maintenance. The Xtrashift 36/12 transmission with three powershift steps (HML) and power shuttle provides a top speed of 50 km/h. A creeper with 48+16 gears ensures speeds as low as 300 m/h. Additional tractor features include a Park Lock device for added safety when parking on slopes, a front hitch with 2250 kg lift capacity and an electronic rear hitch that lifts up to 6000 kg. The closed-centre hydraulic system with 110 l/min total flow operates up to seven remote valves. Thanks to the precision of the satellite-based guidance, the efficient control of ISOBUS-compatible implements, the remote fleet control and diagnostics through the Fleet & Remote Diagnostics Management and the optimum farm management guaranteed by the McCormick Farm system, the X6 contributes to reducing operating costs while increasing productivity.

# McCORMICK X5, VERSATILITY HAS NEVER BEEN SO COMFORTABLE



The McCormick X5 is a utility tractor capable of surprising. Offering the performance, comfort and versatility of a higher class tractor, the X5 is ideally suited for field activities such as ploughing, tillage and harrowing, but is equally perfect for sowing and haymaking, barn work and transport operations. The X5 features a suspended four-post cab with automotive-style fit and finish that provides full all-round visibility. A low-profile cab roof allows easy access to low-ceiling barns and sheds and a transparent roof hatch ensures extra visibility for front loader operation. An ergonomically-designed joystick provides convenient and precise control of all tractor functions and implements. The FPT 3.6L engine meets Stage V emissions regulations and delivers up to 114 hp. The X5 tractor offers an Xtrashift transmission with three-stage HML powershift. The hydraulic system with 82 l/min pump ensures efficient operation of all hydraulic functions and up to six remote valves. The X5 can be optionally equipped with a McCormick front loader; a front hitch and front PTO; a satellite-based guidance system for maximum working accuracy; an ISOBUS system for efficient implement control; a Fleet Management system that monitors your fleet, controls the data of each tractor and performs remote diagnostics. Efficient, versatile and comfortable, the X5 is a valuable workmate you can always rely on.

## HIGHLIGHTS

- › FPT F36 3.6L engine delivering up to 114 hp.
- › Suspended cab with air suspension seat, ergonomic controls, automotive-grade fit and finish and low-profile roof.
- › XtraShift transmission with P3-Drive: 3 powershift speeds (HML) and 4 robotised ranges.
- › Suspended front axle with brakes, full locking differential and electro-hydraulically ally operated four-wheel drive.
- › Open-centre hydraulic system with 82 l/min pump.
- › Electronically-controlled rear hitch with up to 4500 kg lift capacity.
- › Front hitch and front PTO for added versatility.
- › Smart ADS+ steering system for added comfort and productivity.
- › ISOBUS system and Precision Steering Management.
- › McCormick Farm and McCormick Fleet & Remote Diagnostics Management systems for efficient management of your farm and tractor fleet.

### X5 - ROPS Version

The ROPS version of the X5 with its platform mounted on silent blocks to reduce vibration and its easily-accessible driving position with ergonomically-arranged, intuitive controls offers the operator a functional and comfortable work environment. This model also features a folding ROPS with a detachable sunroof.



### SUSPENDED CAB AND SUSPENDED FRONT AXLE

The suspended cab and suspended front axle isolate the operator from shocks and vibrations creating a comfortable work environment that reduces operator stress and increases efficiency and productivity. A new, highly-efficient sound insulation system reduces the noise level inside the cab.



### ADS+ STEERING SYSTEM FOR TOP-CLASS COMFORT AND PRODUCTIVITY

The ADS+ steering system takes efficiency to a whole new level. The system, which is prepared for satellite-based guidance, corrects unwanted tractor movements caused by terrain irregularities and realigns the wheels after a turn, adjusts the steering wheel's stiffness based on the vehicle's speed, and halves the number of steering wheel revolutions required to turn the tractor.



### XTRASHIFT TRANSMISSION WITH P3-DRIVE

The XtraShift transmission with P3-Drive powershift features 3 powershift speeds (HML) and 4 robotised ranges providing 36F + 12R speeds. The de-clutch button and the reverse power shuttle allow the driver to shift through all gears and change from forward to reverse without using the clutch pedal. The shuttle response is electronically modulated.





# McCORMICK X5.085, A UTILITY TRACTOR IN A CLASS OF ITS OWN



## HIGHLIGHTS

- › FPT F34 3.4L, 75-hp engine providing 375 Nm torque at 1400 rpm, without AdBlue.
- › XtraShift transmission with P3-Drive: 3 powershift speeds (HML) and 4 robotised ranges.
- › SmartPilot joystick for control of all tractor functions.
- › Front axle with brakes, full locking differential and electro-hydraulically operated four-wheel drive.
- › Open-centre hydraulic system with dual pump: 56 l/min for remote valves and 32 l/min for steering.
- › Rear hitch with 3900 kg lift capacity. Front hitch with 1700 kg lift capacity.
- › Up to 34" rear tyres.
- › Designed specifically to match the X5.085 model, the sturdy M15 front loader from McCormick enhances tractor versatility and productivity.
- › New ADS+ steering system for increased comfort and productivity.
- › McCormick Farm and McCormick Fleet & Remote Diagnostics Management systems for efficient management of your farm and tractor fleet.

The X5.085 is a really unique utility tractor. Designed with versatility and productivity in mind, the X5.085 delivers up to 75 hp and meets the Stage V/Tier4 Final emission regulations using a urea-free exhaust after-treatment system. This solution reduces engine checks, resulting in lower costs and time saving. This amazing tractor is powered by a highly efficient FPT F34 engine with 3.4L displacement. With a best-in-class torque backup of 56%, the engine of the X5.085 ensures outstanding traction and ease of operation on all terrains. The XtraShift transmission with P3-Drive HML powershift can be conveniently controlled from the SmartPilot joystick. The open-centre hydraulic system with dual pump delivers 56 l/min to the remote valves and 32 l/min to the steering system. Up to three rear-mounted and two mid-mounted remote valves and a flow divider that directs the flow from one remote to two separated outlets enable operator to control up to six different hydraulic functions. The X5.085 features 34-inch tyres for better ground clearance and up to ten LED work lights for best night visibility. This tractor delivers all the power required for soil preparation activities and with its optimum weight-to-power ratio is great for transport tasks on sloping terrain. It is also agile and compact enough for barn work. The McCormick X5.085 is the only tractor capable of combining the advantages of light tractors with the power of utility tractors.

### FPT F34 ENGINE: HIGH PERFORMANCE AND FUEL ECONOMY

FPT F34 3.4L engine with 375 Nm torque at 1400 rpm and up to 56% torque backup: it feels like you have 15 hp more. Delivering 75 hp, this engine meets the Stage V/Tier4 Final emission regulations without using a urea-based after-treatment system, resulting in reduced operating costs.



### STURDY AND NIMBLE FRONT AXLE

The X5.085 features a compact, rigid front axle that enhances the tractor's compact size and agility. Sturdy and reliable, this axle will provide maximum stability and safety both in the field and on the road. With its high ground clearance and its 55° steering angle, the X5.085 provides excellent manoeuvrability in any situation.



### XTRASHIFT TRANSMISSION WITH P3-DRIVE

The XtraShift transmission with P3-Drive powershift features 3 powershift speeds (HML) and 4 robotised ranges providing 36F + 12 REV speeds. The de-clutch button and the reverse power shuttle allow user to shift through all gears and change from forward to reverse without using the clutch pedal. The Stop&Action function allows clutchless stopping of the vehicle.





## McCORMICK X4, YOUR DO-IT-ALL WORKMATE



The X4 light utility tractor from McCormick is a true efficiency champion, capable of handling any job on the farm. The X4 is the ultimate do-it-all tractor for wide-row vineyards and orchards. Ideal for ploughing, tilling and harrowing small plots of land, this tractor is equally perfect for sowing and haymaking. Thanks to its compact size and excellent manoeuvrability, the X4 moves easily in and out barns and sheds and ensures safe operation on steep slopes and during transport. The comfortable Total View Slim cab borrows from the automotive industry. Main features include a low-profile roof with a transparent hatch for extra visibility, a flat floor and a highly-efficient climate control system. All controls are ergonomically designed for ease of use and allow intuitive control of the 12/12 power shuttle transmission and of the 24/24 synchro shuttle transmission with mechanical Hi-Lo. The X4 tractor range comprises three models with power ratings of 61 hp, 68 hp and 75 hp, all without AdBlue. Key features of the X4 include a specially-built transmission, a 4WD front axle with limited slip differential, a 2110 mm wheelbase, a mechanical rear hitch with up to 3000 kg lifting capacity, optional front hitch and PTO, a hydraulic system with up to 52 l/min flow rate and a urea-free exhaust after-treatment system for added reliability and reduced operating costs. When you choose a McCormick tractor, you are choosing technological innovation and uncompromising efficiency and productivity.

### HIGHLIGHTS

- › Three models delivering 61 hp, 68 hp and 75 hp. All models are without AdBlue.
- › Speed Four transmission with 24F + 24R speeds and mechanical Hi-Lo.
- › Power Four transmission with 12F + 12R speeds and power shuttle.
- › Mounting frame for factory-fit McCormick front loader.
- › Open-centre hydraulic system with 52 l/min flow rate.
- › 540/540E PTO plus ground speed.
- › McCormick Farm and McCormick Fleet & Remote Diagnostics Management systems for efficient management of your farm and tractor fleet.

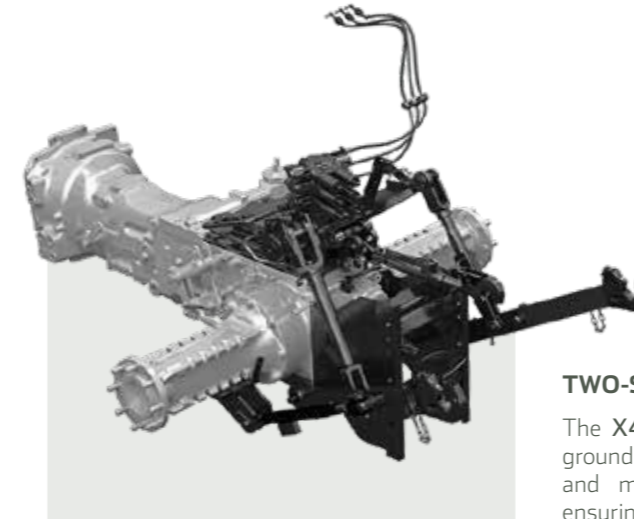

#### TWO-SPEED PTO

The X4 features a rear 540/540E PTO with ground speed. A push button enables smooth and modulated engagement of the PTO, ensuring a soft start-up of implement.



#### McCORMICK FRONT LOADERS

Designed specifically to fit the X4 tractor range, the McCormick front loaders are easy to mount and remove and allow the use of a wide range of implements. The ergonomic joystick control and the transparent roof hatch further enhance comfort and productivity.

### ROPS Version

The ROPS version of the X4 features an iso-mounted platform designed to minimise vibrations. Spacious and easy to access, the driving position provides a high level of comfort, reducing operator fatigue. All controls are ergonomically arranged and user-friendly. The two-post ROPS folds down to allow the tractor to work under low fruits or vines and between narrow row spacings.





## McCORMICK CRAWLER TRACTORS: MISSION IS POSSIBLE

### Champion

Built to tackle tough tasks other tractors can't manage, McCormick crawler tractors are true hillside specialists. They provide superior pulling force while maintaining low ground pressure for reduced soil compaction. Powerful, versatile, comfortable and safe on all slopes, McCormick crawler tractors are true champions that make even the most challenging tasks seem easy.

### Efficiency

McCormick crawler tractors provide best-in-class efficiency thanks to their exceptional traction, flotation, stability and manoeuvrability. The engine provides responsive power to negotiate steep slope and tough conditions, ensuring maximum safety and productivity in any situation. Both the transmission and hydraulic system are designed for maximum configurability. The rear remote quick couplers are high quality and conveniently located. The oil cooler with auxiliary tank ensures optimum performance including under stress conditions. The rear hitch is designed to provide a high lifting capacity. Powerful, versatile and safe, McCormick crawler tractors will crawl into places where other tractors cannot.

### Comfort

Designed to offer comfort and safety in any condition, McCormick crawler tractors are used to tackling slopes, mud and rough ground. The air suspension seat enhances driving comfort on all terrains. Servo-assisted levers allow smooth direction changes. All controls are ergonomically positioned and easy to use. The cab is iso-mounted to reduce vibrations and equipped with sound-insulation and climate control system. McCormick crawler tractors ensure maximum ride comfort, reducing operator fatigue and increasing productivity.

# McCORMICK X4T, REACHING WHERE OTHERS CANNOT



The **X4T** crawler tractor from McCormick is designed to provide all the traction and grip needed to negotiate uneven terrains and steep inclines without compacting the soil. Featuring a platform with Hydro silent block suspension that isolates the driving position from noise and vibrations and protects the operator from engine heat, the **X4T** offers the highest levels of comfort in its class. This model is available in two versions: **X4T F** for vineyard and orchard work and **X4T M** for hillside operation.

The cab of the **X4T**, fitted with athermic windscreens, provides unequalled all-round visibility. Pressurised and equipped with a Category 4 filtration system, the cab protects the operator from dust and pesticide vapours. The driving position is located on a large, lowered platform and equipped with an air-conditioned, top-quality seat and a DAB+ radio system with bluetooth, Mp3 player and handsfree kit. Eight full-LED lights provide optimum visibility during night work. The Deutz AG 2.9L, 8-valve, 4-cylinder turbo aftercooled engines meet Stage V emissions regulations and deliver from 75 to 112 hp. An 80-litre fuel tank ensures long working days without refuelling. The synchro shuttle transmission offers four gears in two ranges providing 16F/8R speeds; it can be equipped with either an overdrive to achieve 15 km/h or a creeper with speeds down to 300 m/h. The hydraulic system features an exclusive triple pump supplying 56 + 28 + 28 l/min for a total flow of 112 l/min. The system offers up to five remote valves with six quick couplers and a flow control valve. The rear hitch, equipped with Ergonomic Lift System (ELS), is the most powerful in its class and provides a lift capacity of up to 4500 kg.

The **X4T F** comes with either 310 or 360 mm wide semi-lubricated steel tracks, while the **X4T M** can be fitted with either 400 or 450 mm lubricated steel tracks; 450 mm wide rubber tracks are also available.

## HIGHLIGHTS

- › Exclusive driving platform suspended on 4 Hydro silent blocks for unparalleled comfort.
- › Grammer high-grade driver's seat with air suspension and comfortable armrests.
- › New, exclusive full-LED lights for powerful lighting.
- › Speed Four transmission: 4 gears and 2 ranges for 16F/8R speeds, with overdrive or creeper.
- › Open-centre hydraulic system with exclusive triple pump providing 56 + 28 + 28 l/min.
- › Rugged rear hitch capable of lifting up to 4500 kg.
- › Scheduled maintenance every 1000 hours.
- › Cutting-edge technology: Fleet & Remote Diagnostics Management, Farm Management.



### HYDRAULIC SYSTEM WITH EXCLUSIVE TRIPLE PUMP

The hydraulic system of the **X4T** features a triple pump that supplies 56 + 28 l/min to the rear hitch and remotes and 28 l/min to the steering system providing a total flow of 112 l/min. The system can be equipped with up to five remote valves with six hydraulic couplers and a flow control system. The servo-assisted PTO offers two speeds: 540/540E or 540/1000 rpm.



### DRIVING PLATFORM WITH HYDRO SILENT BLOCK SUSPENSION

The platform of the **X4T** is suspended on four Hydro silent blocks that fully isolate the driving position from the transmission. This unique technology, that has no equal in the crawler tractor market, protects the operator from engine heat, while minimising vibrations and noise.

## Driving position designed for ultimate comfort

Located on a lowered platform suspended on four Hydro silent block mounts, the driving position of the **X4T** is designed with ultimate comfort in mind. A top-quality seat with air suspension and armrests and a new dashboard with more ergonomic and easy-to-use controls further enhance the driving comfort.





## McCORMICK SPECIALTY TRACTORS: THE FRUITFUL SPECIALISTS

### Performance

High design capacity, cutting-edge production plants, exclusive use of advanced components and strict quality controls make the McCormick tractors a worldwide reference for farmers looking for state-of-the-art technology and no-compromise performance. McCormick has transferred the innovative technology of its high-end tractors into the specialty tractor range to create compact, easy-to-handle vehicles that will offer precise control, maximum operating comfort and versatility. McCormick is the ideal work partner for farmers looking to boost their productivity to new heights.

### Configurability

Every farmer would like to have a tractor tailored to their specific needs. By putting the customer at the centre of its business, McCormick ensures that they receive only what they really need, eliminating unnecessary equipment and expenses. McCormick specialty tractors are highly configurable and allow the user to choose the engine power, the cab model, various operating controls, the type of transmission and front axle, the tyre size, the hydraulic system configuration and other components. Powerful performance, innovative technology and attention to customer's needs turn the McCormick specialty tractors into irreplaceable workmates.

### Versatility

McCormick tractors are not adapted from any existing models but are designed and developed from the scratch around the real needs of farmers. McCormick specialty tractors are no-compromise machines which provide all the versatility required for operating in confined spaces and under low-hanging crops. Combining functional cutting-edge technology with versatility of use, the McCormick specialty tractors allow the operator to fully concentrate on the task at hand without having to worry about the tractor management.

## McCORMICK X5 HC, GRADUATED IN HORTICULTURE



### HIGHLIGHTS

- › Powerful and efficient FPT F36 engine with up to 102 hp.
- › Power Four electrohydraulic transmission with two-speed Hi-Lo powershift.
- › Open-centre hydraulic system with up to 62 l/min dual pump.
- › Ground clearance of up to 700 mm.
- › McCormick Fleet & Remote Diagnostic Management.

The **X5 HC** is the efficient specialty tractor for vegetable crops from McCormick. Designed for best-in-class comfort and productivity, the **X5 HC** is perfect for planting, fertilising, irrigating and harvesting vegetables, fruits, corn, rice and other crops. With its large-diameter equal-sized wheels and narrow tyres, the **X5 HC** achieves a ground clearance of up to 700 mm. This high ground clearance protects delicate crops, reducing potential contact damage to a minimum. The tractor also provides minimal soil compaction and with its impressive agility and tight turning radius makes manoeuvring at headlands and in confined spaces easier than ever. The narrow tyres are type-approved for road transport. The **X5 HC** tractor is available with two power outputs, 95 hp and 102 hp. Designed for enhanced driving comfort, the Total View Slim cab offers a roomy working environment with flat floor; a driver's seat with optional air suspension system; a telescopic tilt-adjustable steering column that tilts with the instrument cluster; ergonomically-placed, easy-to-use controls; automotive-grade fit and finish and roof-integrated air-conditioning to maintain a comfortable working environment whatever the outdoor weather conditions.

#### FPT F36 ENGINES FOR GREATER PRODUCTIVITY

The **X5 HC** tractors are powered by FPT 3.6-litre, 16-valve, 4-cylinder turbo engines with intercooler and common rail injection system that meet the Stage V/Tier 4 Final emissions regulations and deliver 95 and 102 hp. The exhaust after-treatment system is tucked away under the bonnet to ensure full visibility during work.



#### TOTAL VIEW SLIM CAB FOR MAXIMUM VISIBILITY

With its four-post design and generous glazing, the cab of the **X5 HC** tractor provides unmatched visibility in all directions, making manoeuvring in confined spaces easier and safer. Up to 10 LED work lights ensure optimum visibility for night operation.



#### POWER FOUR ELECTROHYDRAULIC TRANSMISSION

The Power Four Hi-Lo doubles the gears of the main transmission providing 24F and 24R speeds. The creeper increases speeds to 32F and 32R. The Power Four transmission features a steering-column synchro or power shuttle and a de-clutch button allowing operator to shift through all gears without use of the clutch pedal.



## CAB

# McCORMICK X4F

## REAPING THE FRUIT OF PRODUCTIVITY



The **X4F** tractor range from McCormick brings a fresh wind into the field of specialty tractors. Available in **F**, **N**, **V** and **XL** versions, the **X4F** Cab features a dynamic design with perfectly integrated Full LED lights, a cab with flat-deck platform and all-round visibility, extendable mirrors and automotive-grade fit and finish. The new **X4F** Cab tractors are powered by Stage V Deutz 2.9-litre, 4-cylinder turbocharged engines with intercooler and common rail injection system that provide power ratings from 75 to 112 hp. The DPR/DOC/SCR after-treatment system is tucked under the bonnet to keep a clean, uncluttered design without compromising on compact size and visibility. The transmission offers 12F + 12R speeds with synchro shuttle and up to 48F + 16R speeds with P3-Drive HML and power shuttle. A multifunction controller provides easy and intuitive control of three-stage on-the-go powershift and speeds. The hydraulic system can be equipped with either an 88 l/min dual pump or a 124 l/min triple pump. The electronic rear hitch offers a lift capacity of 2700 kg and is available on request with up to 3400 kg lift capacity for the **X4F** XL. A front hitch with a lifting capacity of 1700 kg and a 1000-rpm front PTO are supplied on request. The rear PTO is available with a choice of four speeds. To increase the tractor versatility, the **X4F** Cab can be fitted with a mounting frame for mid-mount implements. The tractor can be equipped with: ADS+ and satellite guidance system for maximum precision and ease of operation; ISOBUS system for optimum implement control; Fleet & Remote Diagnostics Management for remote fleet monitoring, data analysis and diagnostics; McCormick Farm for efficient farm management.

### HIGHLIGHTS

- › **X4F** Cab tractor available in four versions: F for orchards, N for narrow-row orchards, V for vineyards, XL for wide-row orchards and open field.
- › Heat and sound insulated Premiere Cab with all-round visibility. Available with Category 4 filtration.
- › Premium and Premium + trim levels, for top-class performance and comfort.
- › P3-Drive HML transmission with robotised control of powershift gears and speeds via a multifunction joystick controller.
- › Reverse Power Shuttle: electrohydraulic power shuttle with electronically adjustable shuttle response.
- › Maintenance intervals extended up to 1000 hours.
- › Hydraulic system with dual pump supplying 30 + 58 l/min or triple pump supplying 36 + 58 + 30 l/min. Up to

- › 88 l/min flow rate available for hitch and remotes. The system supplies 54 l/min already at 1500 rpm.
- › Front and rear ISOBUS connection. The innovative ISOBUS Green system guarantees maximum compatibility with all mechanical and hydraulic implements.
- › McCormick Farm and McCormick Fleet & Remote Diagnostics Management for efficient management of your farm and tractor fleet.

### ADVANCED DRIVING SYSTEM

Specialty tractors require the simultaneous management of tractor and implement functions. The innovative ADS assisted driving system enables the operator to fully concentrate on the job to be performed. All information on the implements is always clearly visible on screens that can be mounted onto a practical monitor bracket.



### SUSPENDED CAB AND FRONT AXLE FOR MAXIMUM COMFORT

The cab is mounted on a Hydro silent block suspension system or optionally on spring-type shock absorbers allowing a vertical travel of -30/+30mm. For the F, N and XL models a suspended front axle is available to effectively reduce vibration levels and improve ride comfort.



### PREMIUM TRIM LEVEL: COMFORT AND EFFICIENCY

New features include: P3-Drive transmission with 12 robotised speeds; multifunction armrest and multifunction joystick for control of key tractor functions such as automatic headland turns, electronic rear hitch, electrohydraulic remotes, and air-suspended swivel seat with integral armrest.



PLAT

## McCORMICK X4F, OPERATOR IS THE DRIVING FORCE OF PRODUCTIVITY



### HIGHLIGHTS

- › X4F Plat tractor available in four versions: **F** for orchards, **GE** for low orchards, **GB** for greenhouses and overhead trellis systems, **XL** for wide-row orchards and open field.
- › Low-profile cab available as an option for unmatched compact size and maximum comfort all year round.
- › Full LED lights and McCormick Red Spirit Limited Edition with metallic red finish and matte black wheel rims for functionality and style.
- › Suspended front axle for the **F** and **XL** versions to increase comfort in the field and on the road.
- › Maintenance intervals extended to 1000 hours.
- › Wide choice of tyres. Set of high-speed rims available as an option.
- › Front and rear ISOBUS connection. The innovative ISOBUS Green system ensures total compatibility with all mechanical and hydraulic implements.
- › McCormick Farm and McCormick Fleet & Remote Diagnostics Management systems for efficient management of your farm and tractor fleet.



#### X4 GB IS SPECIALISED IN LOW-CLEARANCE AREAS

With its 20-inch tyres, a turning radius of only 500 mm and a super compact driving position with a height to the steering wheel of only 1280 mm, the **X4F** is specially designed to work inside greenhouses and under overhead trellis systems but will also glide with ease under the low-hanging branches of the kiwifruit trees.

The McCormick **X4F** Plat tractor range represents a real evolution in the specialty tractor segment. Available in F, GE, GB and GT versions, these tractorS come with either ROPS or a low-profile cab designed for low-clearance applications. The **X4F** Plat puts the operator in focus: Full LED lights, a flat-deck platform mounted on shock absorbing rubber mounts to absorb impacts caused by uneven ground, ease of access to the driving position, optimal steering wheel to seat distance, ergonomically-positioned controls. The Deutz 2.9-litre, 16-valve, 4-cylinder turbo intercooled engines with common rail injection system and power ratings from 75 to 112 hp meet the Stage V emission regulations and deliver more power while improving fuel economy. The transmission provides 12F + 12R speeds with synchro shuttle and up to 48F + 16R speeds with HML three-stage on-the-go powershift and reverse power shuttle. The open-centre hydraulic system can be equipped with either a dual pump providing 30 + 58 l/min for a total flow of 88 l/min or a triple pump supplying 36 + 58 + 30 l/min for a total flow of 124 l/min, with 88 l/min being supplied to the hitch and remotes. The system provides a flow rate of 54 l/min already at 1500 rpm. Available on request are an electronic rear hitch with a lift capacity of 2700 kg and of up to 3400 kg for the **X4 GT** and a front hitch with a lift capacity of 1400 kg. The **X4F** Plat comes loaded with a lot of winning features that turn it into a true profit maker. The tractor can be equipped with: electronic rear hitch with 2700 kg lift capacity; ISOBUS system for optimum implement control; Fleet & Remote Diagnostics Management for remote fleet monitoring, data analysis and diagnostics; McCormick Farm for efficient farm management.

#### EXHAUST AFTER-TREATMENT SYSTEM UNDER THE BONNET

The new engines meet Stage V emission regulations using DPF, DOC, SCR and AdBlue technologies. The after-treatment package is fitted under the bonnet to keep the vehicle height unchanged. This enables the tractor to maintain a compact footprint ensuring full visibility to the front.



#### McCORMICK FLEET MANAGEMENT

The McCormick Fleet Management will allow farmers to increase productivity by analysing the activities of their tractor fleet in real time: worked hours, worked surfaces, consumptions, remote diagnostics. A 3- or 5-year Fleet Management subscription will give subscribers access to the McCormick web portal.





## McCORMICK X3, SPECIALISED IN VERSATILITY



The X3 specialty tractor from McCormick combines a compact design with best-in-class manoeuvrability and versatility. It comes in two versions: X3 F for vineyards and orchards with narrow row spacing and X3 GE for low orchards and vineyards, overhead trellis systems and tunnel crops. Both versions are equally at home in municipal applications. The driving position is available in three versions: ROPS, low-profile cab and standard cab. Creature comforts of the standard cab include a functional monitor bracket. Both models in the range are powered by Kohler 2.5-litre, 16-valve, 4-cylinder engines that deliver 68 hp and 75 hp. The Engine Memo Switch saves and manages the engine revs. The Stage V after-treatment system is fitted beside the bonnet to keep the tractor compact while improving visibility and manoeuvrability. The synchro shuttle transmission provides up to 16F + 16R speeds with creeper. With an external width of 1350 mm, a minimum height to steering wheel of 1265 mm and a wheelbase of only 1950 mm, the X3 combines an extremely compact footprint with a tight turning radius. This improves manoeuvrability while reducing working time, operator fatigue and fuel consumption. To maximise tractor versatility, the X3 comes fitted with supports for the attachment of mid-mounted implements that can be used in combination with a front hitch and PTO. With the X3 McCormick meets the challenge of providing useful technology that enhances driving comfort and productivity.

## HIGHLIGHTS

- › The X3 tractor is designed for maximum versatility and compatibility with rear-, front- and mid-mounted implements. Front PTO and front hitch with up to 1000 kg lift capacity.
- › Kohler Stage V 2.5L, 4-cylinder engines deliver 68 and 75 hp and achieve maximum torque at low engine rpm.
- › DOC/DPF exhaust after-treatment system without regeneration located beside the bonnet to keep a compact size and increase operator visibility and efficiency.
- › The Engine Memo Switch stores and recalls the ideal engine revs for smoother headland turns.
- › Front axle with electrohydraulic differential lock and four-wheel drive braking.

### MID-MOUNT SUPPORTS STANDARD

Now the X3 is even more versatile thanks to its mid-mount supports. These innovative, factory-fitted supports allow connecting implements specifically designed to work between crop rows or in confined spaces where a reduced footprint is paramount.



### LOW-PROFILE MONOCOQUE CAB

To minimise foliage damage, the X3 has been built with a small footprint: width at the base 116 cm, width at the top 86 cm, height from the ground 187 cm. The low-profile cab features wide access doors, a tilt steering wheel, a multifunctional console, climate control system, radio and backup camera. All control levers are located close to driver, leaving the central tunnel uncluttered.



### WAFFLE RIMS

McCormick has introduced waffle rims, a technology used on open field tractors, on its X3 specialty tractor range. These high-strength wheel rims are designed to support heavier loads and improve stability both in the field and on the road. This results in enhanced driving comfort and safety.

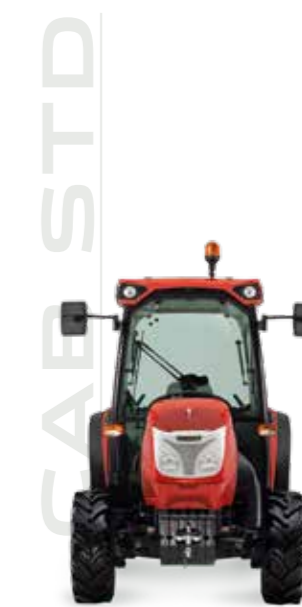

# McCORMICK X2: SMALL OUTSIDE, BIG INSIDE



## HIGHLIGHTS

- › The lowest bonnet and steering wheel in this tractor class, only 1130 mm from the ground: ideal for vegetable farming, greenhouse operations, vine and fruit growing under overhead trellis systems.
- › Tractor design with innovative, dynamic lines for functionality and style.
- › High comfort: four-post cab with superior all-round visibility, opening front and rear windscreens, spacious driving position, tilt-adjustable steering wheel, ergonomic controls, automotive-style fit and finish, radio and climate control.
- › Front four-wheel drive axle with Hydralock differential lock and four-wheel braking for agility, traction and safety in all terrain conditions.
- › High-flow pump with 35 + 20 l/min and up to 3 remote valves for optimum operating efficiency and total implement compatibility.

The X2 combines superior performance with eco-friendly solutions. Designed with lightweight and agility in mind, this tractor ensures optimum manoeuvrability and reduced soil compaction, making it the ideal choice for vegetable growing farms, greenhouses, vineyards and orchards grown on overhead trellis systems as well as for municipal applications like maintenance of green spaces.

The X2 provides high, environment-friendly performance relying on a Stage V Kohler KDI 1903 TCR 1.9-litre, three-cylinder turbo aftercooled engine that delivers 49 hp and 57 hp and achieves best-in-class peak torques of 180 and 200 Nm already at 1200 rpm. The transmission with steering-column synchro shuttle provides 12F + 12R speeds that can be increased to 16F + 16R with a creep speed unit. Featuring a minimum height of only 1230 mm from the ground for the STD version and 1130 mm for the GE version, the X2 has the lowest bonnet in its class; this results in improved visibility to the front and easy operation in low-clearance areas. With a minimum width of only 1260 mm, the X2 is also the most compact specialty tractor in its class. In addition, the tractor's tight turning radius and the wheelbase of only 1790 mm, the shortest in the segment, make headland turns easier and faster, thereby reducing working time, fuel consumption and operator fatigue. The X2 embodies compactness and uncompromising performance and comfort.

### McCORMICK X2, DESIGNED TO BE COMPACT

Specially designed for vegetable growing farms, greenhouses, vineyards and orchards grown on overhead trellis systems, the X2 comes fitted with 20" and 24" rear tyres for maximum traction performance and stability. The front and rear axles of the X2 GE are respectively 100 mm and 95 mm lower than on the X2 STD.



### POWERFUL STAGE V KOHLER ENGINE

More powerful: Kohler KDI 1903 TCR engines with 49 hp and 57 hp and max torques of 180 Nm and 200 Nm already at 1200 rpm. More eco-friendly: engines meet Stage V emission regulations. More clean and uncluttered: the exhaust after-treatment system is located in a lower position, out of operator's visual field. More productive: the DPF system reduces downtime.



### BEST-IN-CLASS TECHNOLOGY AND EFFICIENCY

The instrument panel displays: tractor conditions, engine diagnosis, PTO and advance speeds, information on work area and consumptions. In addition, the McCormick Fleet Management monitors: efficiency, consumptions, working hours and maintenance.





## McCORMICK DIGITAL SOLUTIONS BRING THE FUTURE TO THE FIELD

Technological innovation improves working conditions, increases productivity and protects the environment. Following this philosophy, the Argo Tractors Group has prepared its tractors for the most cutting-edge digital and telematic technologies. This will help farmers manage their machinery fleets and their farms more efficiently and remotely, wherever they are. **McCormick Digital Solutions** offers a range of advanced functionalities:

**Telemetry and Remote Diagnostics:** Thanks to the Fleet & Remote Diagnostics Management system, telemetry monitors your fleet analysing tractor performance data, while remote diagnostics enables tractor parameters to be monitored and managed from a remote location

**Precision Farming:** The Precision Steering Management satellite guidance system improves working accuracy and efficiency; the ISOBUS system ensures efficient control of implements, including in automatic mode.

**Farm Management:** McCormick Farm manages prescription maps and simplifies farm management.

**Digital Services:** The My McCormick app provides easy access to the McCormick world.

**Cloud Data:** The Agrirouter cloud platform allows integrated communication among all services.

**McCormick Digital Solutions** give you more performance, more efficiency and more profitability while improving simplicity, safety and comfort.



## FLEET & REMOTE DIAGNOSTICS MANAGEMENT: PROFIT ASSURED

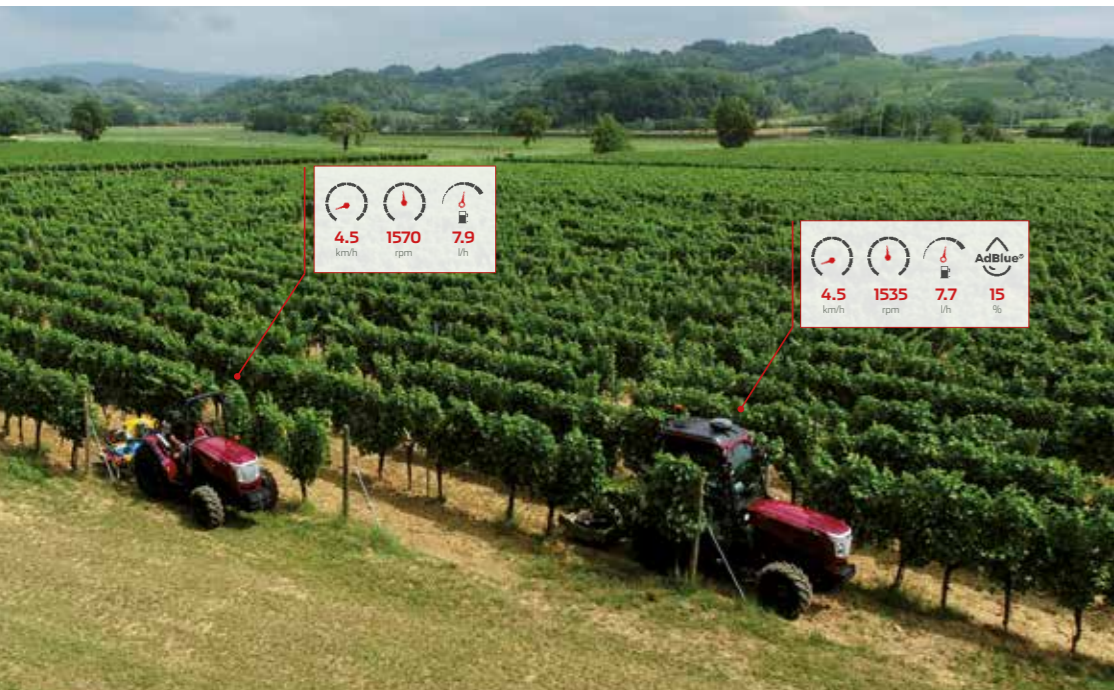

McCormick, a brand globally recognised as synonymous with high performance and cutting-edge technology, equips all its tractors with remote management and diagnostic capabilities. The **McCormick Fleet & Remote Diagnostics Management system** helps farmers make informed data-driven decisions that will reduce their operating costs while increasing the efficiency and productivity of their farms. The system, which can be easily accessed from a computer or a mobile device, allows farmers to remotely monitor the activity of each tractor and analyse the data of their entire fleet of vehicles. This advanced solution is based upon four key elements:

1. Real-time fleet monitoring
2. Data analysis
3. Scheduled maintenance and remote diagnostics
4. Activity history

McCormick is fully committed to addressing the needs of modern agriculture with concrete and effective solutions. The **McCormick Fleet Remote Diagnostics Management system** helps farmers manage their farms more efficiently by favouring the most appropriate choices in order to maintain their tractors in good working order, optimise their work and increase their business profitability.

**1. Real-time fleet monitoring:** The system displays at all times the exact location of each tractor in a fleet and, using the Geofencing technology, notifies whenever a vehicle enters or exits a specified zone. It also measures the efficiency of each tractor by checking parameters like speed, engine hours and RPMs, fuel and AdBlue levels, average consumptions and work progress.

**2. Data analysis:** The data coming from the tractors allow the system to measure the productivity of each vehicle in the fleet and the farm's operating profit. These data are essential to monitor and reduce costs, make predictions, organise work plans and take informed decisions.

**3. Scheduled maintenance and remote diagnostics:** The tractor fleet is managed in a simple and fast manner. In case of failure, our aftersales service intervenes remotely in real time in order to adopt the most appropriate solutions and to improve the tractor's performance, thereby reducing downtime and extending the equipment's life.

**4. Activity history:** This function delimits the work areas and stores the data of the activities performed. This allows the user to better organise the work, increase efficiency and productivity and maximise profitability.



## McCORMICK FARM TECHNOLOGY FOR A MORE PRODUCTIVE FARM

McCormick improves the efficiency of your farming operations. But not only this: **McCormick Farm** connects your tractor to an intelligent and intuitive farm management system. This brings farmers a number of benefits in terms of time saving, work simplification and enhanced performance.

### 360-degree management solutions for your farm

**McCormick Farm** supports more than 400 different crops and allows virtually all tasks on the farm to be accomplished, including crop management, tracking and planning of field activities, advice on crop protection and irrigation practices, creation and exchange of prescription maps with monitoring of costs and sustainability, export of documents.

### Connected to your McCormick

By connecting your McCormick to the **McCormick Farm** app, you can view performance levels and reports on the farming activities carried out in the fields. In addition, you can display prescription maps, A/B lines, boundaries and obstacles.

### Always at your fingertips

Whether in the field or on the farm, McCormick is always at your side, thanks to the **McCormick Farm** app for smartphone and tablet. And if you want to run your business from your computer, you may access the web version synchronised with the mobile devices.

### Simple and intuitive

**McCormick Farm** is designed to be clear and user-friendly. A support chat answers questions about the use of the app.





## PRECISION STEERING MANAGEMENT FOR PRECISION PERFORMANCE



Precision farming has been in existence ever since man started to cultivate land. Today, thanks to technological development, precision farming is carried out with cutting-edge tools that improve efficiency and increase productivity.

McCormick uses the innovative **PSM (Precision Steering Management)** system, a set of integrated devices for satellite-assisted guidance that can be managed from the tractor cab via an intuitive touch screen, on which the tasks to be performed in the field can be easily imported. Thanks to the precise automated steering control, the tractor only deviates 2 cm from the desired route, eliminating overlaps. This helps operators work with more speed and accuracy and reduces operating costs and environmental impact while raising efficiency and productivity in the field.

## ISOBUS & ISOBUS GREEN MAKE YOUR WORK SIMPLE AND EFFICIENT

In 2015, Argo Tractors received the AEF ISOBUS certification. The **ISOBUS** system is the standard protocol through which the on-board computer communicates with the tractor and implements. The automatic control of **ISOBUS**-compatible implements allows variable-rate applications to be delivered through prescription maps generated by McCormick Farm. All **ISOBUS**-compatible implements are managed via a DSM 12"

touch screen monitor to improve operating efficiency and productivity. McCormick is a leading participant in the innovative **ISOBUS Green** project. This project allows farmers to retrofit their mechanical implements with the technology so as to connect them to the tractor's **ISOBUS** system. This solution maximises the efficiency of every implement.

### Precision Steering Management & ISOBUS bring benefits into the field

The **Precision Steering Management** and the **ISOBUS** system are innovative technologies adopted by McCormick to increase efficiency and productivity while improving comfort and safety:

- › All implement activities are managed with a high level of accuracy, including in automatic mode.
- › Difficult manoeuvres are simplified, thereby reducing operator fatigue.
- › When the driver must attend to driving and simultaneously control the implements, the PSM satellite-based guidance system will allow them to fully concentrate on the task at hand.
- › The satellite guidance system tracks field operations with maximum accuracy.

Thanks to the RTK protocols, the automatic steering allows a deviation of only 2 cm from the set route.

- › Reducing the travelled distance in the field reduces tractor and implement wear and tear and saves fuel.
- › The use of variable-rate applications based on prescription maps generated by the McCormick Farm platform eliminates skips and overlaps, minimizing product waste. Variable-rate technology reduces overuse of water, seed use by 10%, fertilizer use by 16% and herbicide use by up to 60%.
- › Chemical residues are also reduced with significant benefits for the environment.
- › Reports and pre-setting operations are simpler and can be done autonomously without recourse to skilled personnel.

# ARGO TRACTORS FLEET ROUTER MANAGEMENT SIMPLIFIES YOUR WORK

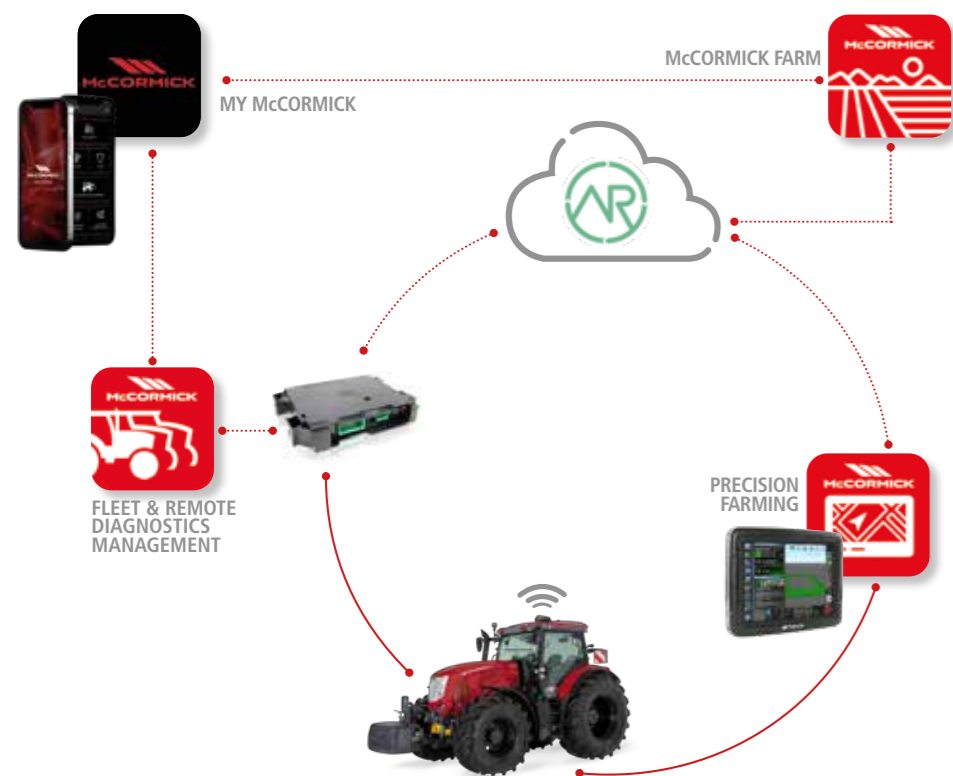

The new digital technologies have rapidly multiplied the sources and destinations of data. Today, it is paramount for both small farmers and large agricultural businesses to enable different systems to communicate with each other. For this reason, on March 30, 2023, Argo Tractors has become an **Agrirouter** certified partner with the account *Argo Tractors Fleet Router Management*. **Agrirouter** is a universal data exchange cloud platform that allows the interchange of information between machinery, equipment and software of different manufacturers. **Agrirouter** links different sources and platforms, simplifying the operating processes and ensuring data confidentiality. The operator keeps everything under control with a single system. By connecting the tractor to the implements, including those from different manufacturers, and to the McCormick Farm platform, a simple and efficient integrated management of both machinery and farm is achieved.

# MY McCORMICK APP, THE McCORMICK WORLD IN YOUR HAND

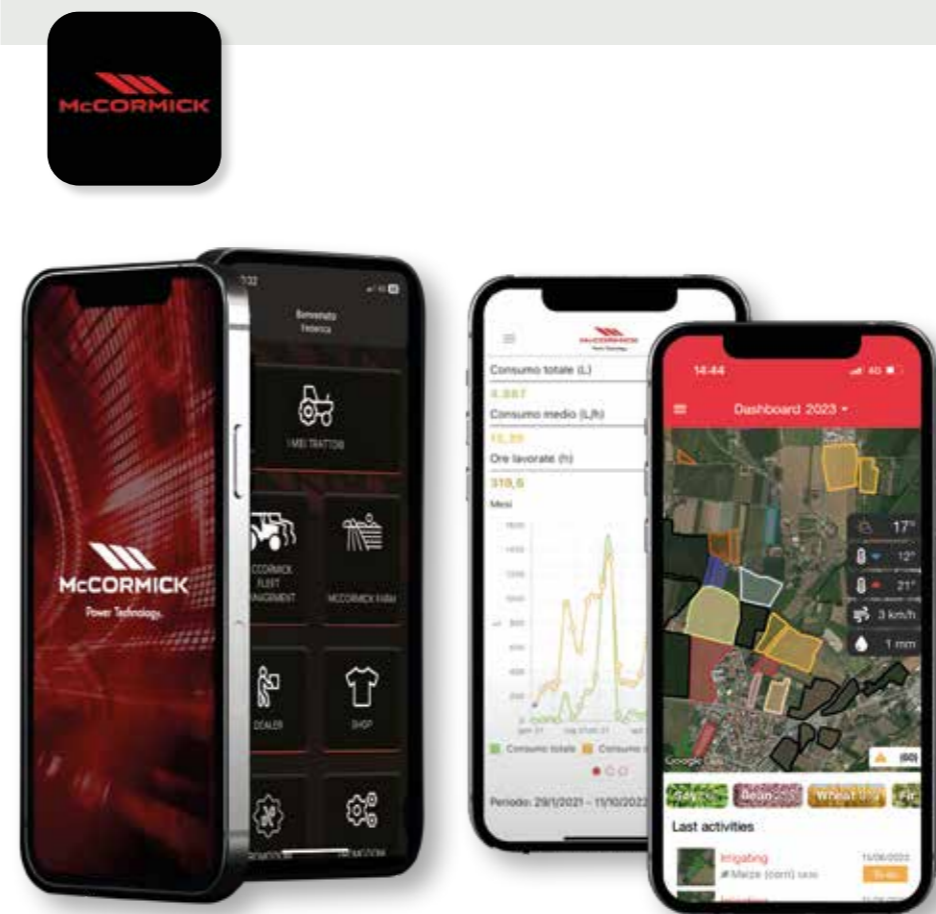

The intuitive **My McCormick** app offers the user a 360-degree immersive experience through our Digital Solutions. The **My McCormick** app gives you easy access to all McCormick digital services, allowing you to stay connected with the company through news, insights, offers and customised information. With **My McCormick** you can:

- > Register your McCormick tractor fleet and access the scheduled maintenance program.
- > Access the McCormick Fleet & Remote Diagnostics Management system.
- > Access the McCormick Farm platform.
- > Stay updated with the very latest news and events from the McCormick world.
- > Stay informed on promotions and offers of tractors, original spare parts and services.
- > Stay updated with new products, promotions and events from the nearest dealer.

McCormick is always at your side. With the **My McCormick** app you have the whole McCormick world at your fingertips, so you stay informed and optimise your work making it more efficient and productive.



## EXTENDED WARRANTY FOR PEACE OF MIND

A new extended warranty of five years or 5000 hours of operation on all tractor components, excluding wearable parts such as brakes, is the most cost-effective solution to protect your McCormick tractor fleet. In addition, the Full option provides comprehensive coverage with no deductible. And that's not all. The warranty extension package is tailored to the needs of each farm and adapted to each tractor model: you can choose between a year-based and an hour-based warranty period.

The extended warranty can be combined with scheduled maintenance packages to keep your tractor in good working order over time, thereby protecting the resale value of the vehicle. In addition, if you choose the warranty extension and scheduled maintenance options at the time of tractor purchase, these can be included in the purchase financing. Ever since its foundation, McCormick has always put the needs of farms and farmers at the core of its solutions.



## SCHEDULED MAINTENANCE FOR GUARANTEED EFFICIENCY

Proper scheduled maintenance performed on an ongoing basis will make your tractor more efficient, reliable and durable. A correct preventive maintenance will also minimise extraordinary maintenance operations, thereby preventing costly downtime. McCormick scheduled maintenance is done at our dealerships by solution-oriented trained technicians who use state-of-the-art diagnostic equipment and technology. To meet every customer's needs, McCormick has developed modular service packages to be performed at preset hour intervals. In addition, all our customers can rely on prices that are:

- > **Fair:** lower than the cost of individual maintenance services;
- > **Clear:** inclusive of labour and genuine maintenance parts;
- > **Firm:** locked in and protected from increases.

And that's not all: if purchased in conjunction with the tractor, the scheduled maintenance package can be included in the financing. By choosing McCormick you can focus on work and productivity, while our qualified staff will take care of everything else.

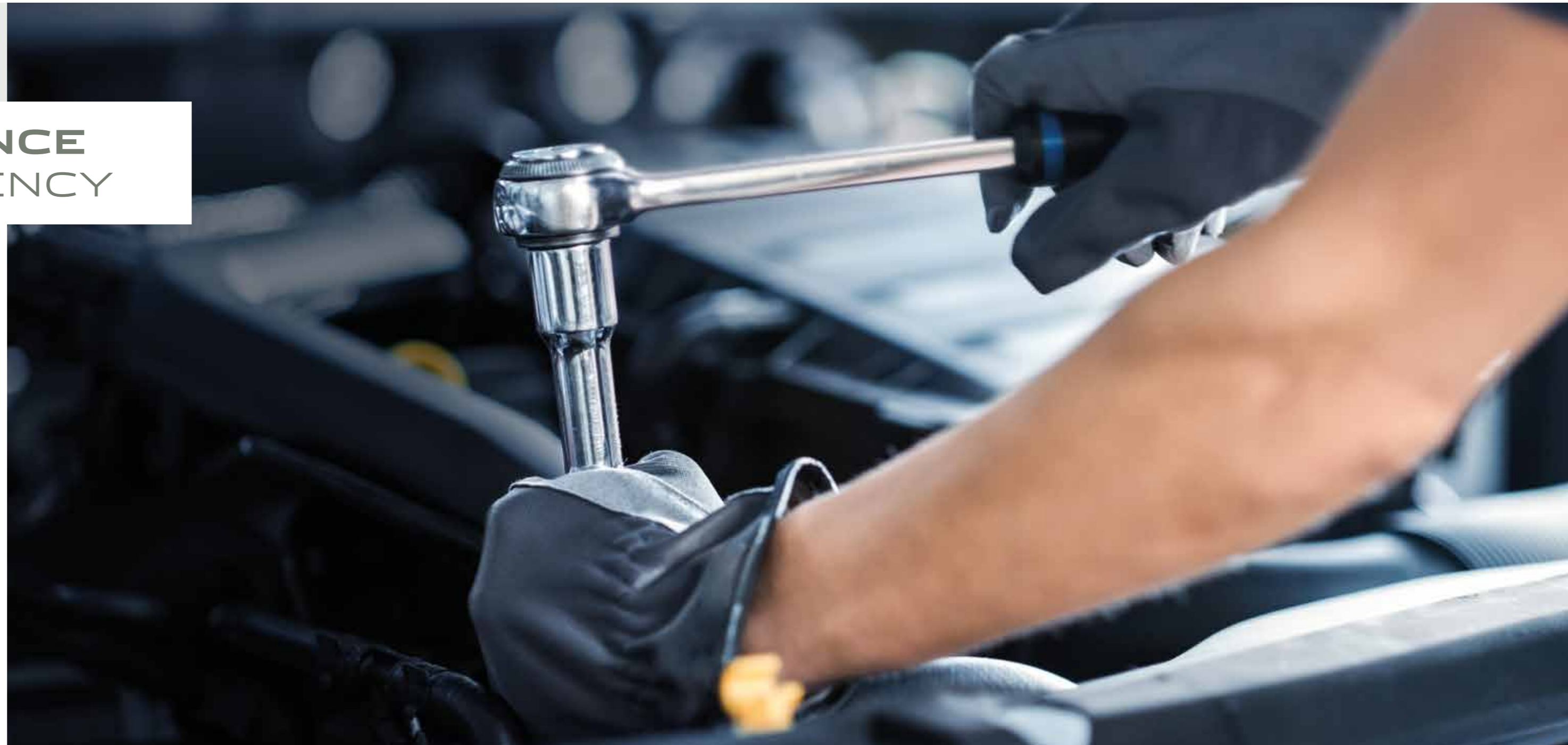





## McCORMICK ORIGINAL SPARE PARTS, THE CORNERSTONE OF YOUR PRODUCTIVITY

Although it works hard, your McCormick tractor always looks good as new. With McCormick original parts, time seems to have stopped. Our original spare parts are an integral part of our scheduled maintenance and extended warranty program. Developed by the same engineers who design and manufacture the McCormick tractors, genuine McCormick parts are designed and manufactured to the highest quality standards to ensure reliable and safe performance over time. The strong points of McCormick original spare parts are the following:

- **Speed:** Spare parts are always shipped within 24 hours of order receipt.
- **Quality:** Each part comes with a 12-month warranty and is marked with a tamper-proof hologram that certifies the product's quality and originality.
- **Value for Money:** Original McCormick parts are reliable and convenient: they improve your tractor performance, maintain high productivity levels and preserve your tractor's value. All McCormick spare parts rely on our extensive design and manufacturing expertise. When you choose McCormick, you are choosing quality without compromise.



### 1847

McCormick sets up a factory in Chicago to manufacture his mechanical reapers.

1866. Red is chosen as the official McCormick brand colour.

1871. McCormick is the most productive company in the world: 250 reapers per day, exported all over the world.

1902. Banker J.P. Morgan acquires McCormick that will be merged with Deering, Plano and Milwaukee Harvester to form International Harvester Company (IHC), the world's largest farm machinery group. Cyrus Hall McCormick Junior is appointed as President.



### 1906

IHC unveils its first tractor, the Mogul 8-16.



### 1910

IHC launches a large, high horsepower tractor, the Titan 10-20. New factories are established in Canada, UK, Germany, France and Sweden.



### 1919

IHC develops the first commercial power take-off.

### 1923

IHC launches the legendary Farmall series, a revolutionary range of lightweight tractors. Farmall becomes the brand name of a line of tractors and implements for ploughing, cultivating and harvesting.



### 1949

Production of McCormick Farmall tractors starts at Doncaster, UK.



### 1951

Production of Farmall tractors starts at St. Dizier, France.

### 1970

The World Wide series is introduced. This is Europe's first tractor range to incorporate synchromesh and hydrostatic transmissions.

### 1970

The company is acquired by Italy-based Argo Tractors Industrial Group which relaunches it under the brand name McCormick Tractors International Ltd. McCormick purchases the Doncaster manufacturing plant.



### 2002

The MC115, MTX, MTX200 and Power6 tractors roll off the production line.



### 2005

The McCormick Diamond Edition is launched.



### 2010

The entire production is concentrated in the new Argo Tractors facilities.

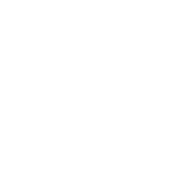

### 2013

The X7 Series, entirely designed by Argo Tractors, debuts in Paris. It features a new ZF transmission. A continuously variable transmission (CVT) is also introduced. It is the beginning of a new era.



### 2015

The high-horsepower lineup debuts with the 310-hp X8 VT-Drive series. Xtractor documentary is shot; protagonist of the video series is a team of McCormick tractors travelling over 8000 km across Australia.

### 2017

The McCormick X6.4 VT-Drive with continuously variable transmission is named Best Utility tractor at the 2018 edition of the Tractor of the Year awards. A new branch is opened in Spain. The Spanish office also takes care of the French and German markets.



### 2019

After Australia, the Xtractor team leaves for a new expedition across South Africa: the itinerary of 8000 km is covered in 50 days.



### 2021

The X7.624 Stage V 6-cylinder tractor enters production. The new design of the bonnet and cab roof, adopted also on the Stage V X8 VT-Drive model, improves the looks and visibility of the vehicle.

### 2021

McCormick offers a comprehensive range of tractors from 43 to 310 hp. The launch of the new Stage V X8 VT-Drive, X7.6 VT-Drive and P6 Drive models confirms McCormick's commitment to ongoing technological innovation and uncompromised performance.



# POWER TECHNOLOGY, SINCE 1847

Cyrus Hall McCormick was born in Virginia, United States, in 1809. A keen inventor, he stunned the agricultural world with inventions that mechanised the farm work. In 1831 he invented the first mechanical reaper. In 1847 McCormick established a factory for the production of grain harvesters. In 1866 the company adopted the red colour that still identifies the brand worldwide. In 1871 McCormick manufactured more machines than any other company in the world: 250 reapers per day. The first tractor, the Mogul 8-16, was launched in 1906. In those years, the company opened up factories in Canada, Great Britain, Germany, France and Sweden.

In 2000, after several changes of ownership, McCormick was acquired by the Argo Group, which relaunches the brand under the name McCormick Tractors International Limited. Today, McCormick is a world leader in the tractor industry and its name stands for uncompromising technology and innovative design. Thanks to heavy investments in research and development, the new generation of McCormick tractors leads the market for performance and innovation. Farmers look for efficient, reliable and versatile solutions to maximise their productivity – and this is exactly what we are proud to offer our customers.

<b>X8 VT-DRIVE</b>		<b>X8.627 VT-DRIVE</b>	<b>X8.631 VT-DRIVE</b>
<b>ENGINE</b>			
Rated power (ISO TR 14396)	hp / kW	250 / 184	301 / 221
Max power (ISO TR 14396)	hp / kW	273 / 201	313 / 230
Max torque at 1400 rpm	Nm	1173	1282
Manufacturer - Engine type - Installation	FPT - N67 - iso-mounted on cast iron chassis		
Stage V - Tier 4 Final exhaust after-treatment system	HI-eSCR2		
Cylinders - Displacement - Valves	6 - 6.71 - 24		
<b>TRANSMISSION</b>			
Type	VT-Drive - continuously variable transmission		
No. of stages	4		
Transmission control	EasyPilot with multifunction armrest		
<b>REAR PTO</b>			
Speeds	540 E / 1000 / 1000 E		
<b>FRONT AND REAR AXLES</b>			
Front suspended axle	● parallelogram suspension system		
<b>HYDRAULIC SYSTEM</b>			
Hydraulic piston pump with CCLS system - flow rate	● 212 l/min		
Rear remote valves - type, flow rate, min - max	● 4 + 3 electrohydraulic, 140 l/min - ○ 6 + 3		
<b>REAR 3-POINT HITCH</b>			
Max lift capacity at the hooks - ram diameter	kg	● 12000 - 120 mm	
<b>FRONT 3-POINT HITCH</b>			
Lift capacity at the hooks (OECD)	kg	5000	
<b>FRONT PTO</b>			
Type	○ electrohydraulic multidisc clutch with modulated engagement		
<b>CAB</b>			
Clever Cab - 4-post cab with McCormick semi-active suspension system	● electronically-controlled electrohydraulic semi-active cab suspension		
In-cab noise level	68		
EasyPilot with multifunction armrest	●		
DSM Data Screen Manager	● 12" touch screen monitor		
DSM Plus	○ 12" digital instrument cluster and 12" main touch screen monitor		
<b>ON-BOARD TECHNOLOGY</b>			
PSM Precision Steering Management, rear ISOBUS and EasySteer	○ EGNOS full kit (20 cm precision) - ○ RTK NTRIP full kit ( 2 cm precision)		
McCormick Fleet & Remote Diagnostics Management - ready	●		
McCormick Fleet & Remote Diagnostics Management and McCormick Farm Pro Pack	on selected markets - ● 1 year - ○ 3 years - ○ 5 years		
<b>WEIGHTS AND DIMENSIONS</b>			
Wheelbase	mm	3000	
Shipping weight - measured with average specs	kg	11000	
Gross vehicle weight	kg	16000	
Max front and rear tyre sizes - (Index Radius - IR)	mm	650/65R34 (IR 775) - 900/60R42 (IR 1025)	

Key: ● standard ○ option

<b>X7.6 CLEVER CAB</b>		<b>X7.621 VT-DRIVE</b>	<b>X7.624 VT-DRIVE</b>
<b>ENGINE</b>			
Max power (ISO TR 14396)	hp / kW	200 / 147	230 / 169
Max power with EPM (ISO TR 14396)	hp / kW	210 / 155	240 / 176
Max torque without EPM (with EPM) at 1400 rpm	Nm	840 (860)	966 (983)
Manufacturer - Engine type - Installation	FPT - N67 - iso-mounted on cast iron chassis		
Stage V - Tier 4 Final exhaust after-treatment system	HI-eSCR2		
Cylinders - Displacement - Valves	6 / 6.71 / 24		
<b>TRANSMISSION</b>			
Type	VT-Drive - continuously variable transmission		
No. of stages	4		
Transmission control	EasyPilot with multi-function armrest		
Smart Power Zero	●		
<b>REAR PTO</b>			
Speeds	540 / 540 E / 1000 / 1000 E		
<b>FRONT AND REAR AXLES</b>			
Front suspended axle	○ IFS - independent front wheel suspension system		
<b>HYDRAULIC SYSTEM</b>			
Hydraulic piston pump with CCLS system - flow rate	● 160 l/min		
Remote valves - type, flow rate, min - max	● 4 electrohydraulic, 100 l/min - ○ 5 - 4+2		
<b>REAR 3-POINT HITCH</b>			
Max lift capacity at the hooks - ram diameter	kg	● 9300 - 100 mm	
<b>FRONT 3-POINT HITCH</b>			
Lift capacity at the hooks (OECD)	kg	3500	
<b>FRONT PTO</b>			
Type	○ - electrohydraulic multidisc clutch with modulated engagement		
<b>CAB</b>			
Clever Cab - 4-post cab with McCormick mechanical suspension system	●		
McCormick semi-active suspension system	○ electronically-controlled electrohydraulic semi-active cab suspension		
In-cab noise level	68		
EasyPilot with multi-function armrest	●		
DSM Data Screen Manager	● 12" touch screen monitor		
DSM Plus	○ 12" digital instrument cluster and 12" main touch screen monitor		
<b>ON-BOARD TECHNOLOGY</b>			
PSM Precision Steering Management, rear ISOBUS and EasySteer	○ EGNOS full kit (20 cm precision) - ○ RTK NTRIP full kit ( 2 cm precision)		
McCormick Fleet & Remote Diagnostics Management - ready	●		
McCormick Fleet & Remote Diagnostics Management and McCormick Farm Pro Pack	on selected markets - ● 1 year - ○ 3 years - ○ 5 years		
<b>WEIGHTS AND DIMENSIONS</b>			
Wheelbase	mm	2820	
Shipping weight - measured with average specs	kg	8300	
Gross vehicle weight	kg	13000	
Max front and rear tyre sizes - (Index Radius - IR)	mm	600/60R30 (IR 700) - 710/60R42 (IR 925)	

Key: ● standard ○ option

<b>X7.6 CLEVER CAB</b>		<b>X7.620</b> P6-DRIVE	<b>X7.621</b> P6-DRIVE	<b>X7.623</b> P6-DRIVE
<b>ENGINE</b>				
Max power (ISO TR 14396)	hp / kW	180 / 132	200 / 147	215 / 158
Max power with EPM (ISO TR 14396)	hp / kW	190 / 140	210 / 155	225 / 166
Max torque without EPM (with EPM) at 1400 rpm	Nm	756 (778)	840 (860)	904 (921)
Manufacturer - Engine type - Installation	FPT-N67 - iso-mounted on cast iron chassis			
Stage V - Tier 4 Final exhaust after-treatment system	HI-eSCR2			
Cylinders - Displacement - Valves	6 / 6.7 l / 24			
<b>TRANSMISSION</b>				
Type	P6-Drive - 6 powershift speeds and 5 robotised ranges			
No. of gears	● 30 F + 15 R without creeper - ○ 54 F + 27 R with creeper			
Transmission control	EasyPilot with multi-function armrest			
APS - Auto PowerShift	● electronically-controlled automatic powershift and range shifting			
<b>REAR PTO</b>				
Speeds	540 / 540 E / 1000 / 1000 E			
<b>FRONT AND REAR AXLES</b>				
Front suspended axle	○ IFS - independent front wheel suspension system			
<b>HYDRAULIC SYSTEM</b>				
Hydraulic piston pump with CCLS system - flow rate	● 160 l/min			
Remote valves - type, flow rate, min - max	● 4 electrohydraulic, 100 l/min - ○ 5 - 4+2			
<b>REAR 3-POINT HITCH</b>				
Max lift capacity at the hooks - ram diameter	kg	● 9300 - 100 mm		
<b>FRONT 3-POINT HITCH</b>				
Lift capacity at the hooks (OECD)	kg	3500		
<b>FRONT PTO</b>				
Type	○ electrohydraulic multidisc clutch with modulated engagement			
<b>CAB</b>				
Clever Cab - 4-post cab with McCormick mechanical suspension system	●			
McCormick semi-active suspension system	○ electronically-controlled electrohydraulic semi-active cab suspension			
In-cab noise level	dB(A)	68		
EasyPilot with multifunction armrest	●			
DSM Data Screen Manager	● 12" touch screen monitor			
DSM Plus	○ 12" digital instrument cluster and 12" main touch screen monitor			
<b>ON-BOARD TECHNOLOGY</b>				
PSM Precision Steering Management, rear ISOBUS and EazySteer	○ EGNOS full kit (20 cm precision) - ○ RTK NTRIP full kit ( 2 cm precision)			
McCormick Fleet & Remote Diagnostics Management - ready	●			
McCormick Fleet & Remote Diagnostics Management and McCormick Farm Pro Pack	on selected markets - ● 1 year - ○ 3 years - ○ 5 years			
<b>WEIGHTS AND DIMENSIONS</b>				
Wheelbase	mm	2820		
Shipping weight - measured with average specs	kg	8000		
Gross vehicle weight	kg	13500		
Max front and rear tyre sizes - (Index Radius - IR)	mm	600/60R30 (IR 700) - 710/60R42 (IR 925)		

<b>X7 SWB CLEVER CAB</b>		<b>X7.417</b> P6-DRIVE	<b>X7.418</b> P6-DRIVE	<b>X7.617</b> P6-DRIVE	<b>X7.618</b> P6-DRIVE	<b>X7.418</b> VT-DRIVE	<b>X7.618</b> VT-DRIVE
<b>ENGINE</b>							
Max power (ISO TR 14396)	hp/kW	155 / 114	165 / 122	155 / 114	165 / 122	165 / 122	165 / 122
Max power with EPM (ISO TR 14396)	hp/kW	165 / 122	175 / 129	165 / 122	175 / 129	175 / 129	175 / 129
Max torque without EPM (with EPM) at 1400 rpm	Nm	652 (676)	700 (700)	652 (676)	694 (737)	700 (700)	694 (737)
Manufacturer - Engine type - Installation	FPT - N45 structural engine		FPT - N67 structural engine		FPT - N45 structural engine	FPT - N67 structural engine	
Stage V - Tier 4 Final exhaust after-treatment system	HI-eSCR2						
Cylinders - Displacement - Valves	4 / 4.5 l / 16		6 / 6.7 l / 24		4 - 4.5 l - 16	6 - 6.7 l - 24	
<b>TRANSMISSION</b>							
Type	P6-Drive - 6 powershift speeds and 5 robotized ranges					VT-Drive Trasmissione a variazione continua	
No. of gears	● 30 F + 15 R without creeper - ○ 54 F + 27 R with creeper					4	
Transmission control	EasyPilot with multifunction armrest						
APS - Auto PowerShift	● electronically-controlled automatic powershift and range shifting						
<b>REAR PTO</b>							
Speeds	540 / 540 E / 1000 / 1000 E						
<b>FRONT AND REAR AXLES</b>							
Front suspended axle	○ IFS - independent front wheel suspension system						
<b>HYDRAULIC SYSTEM</b>							
Hydraulic piston pump with CCLS system - flow rate	● 123 l/min - ○ 160 l/min						
Remote valves - type, flow rate, min - max	● 3 electrohydraulic, 100 l/min - ○ 4 - 5 - 3+2 - 4+2						
<b>REAR 3-POINT HITCH</b>							
Max lift capacity at the hooks - ram diameter	kg	● 9300 - 100 mm					
<b>FRONT 3-POINT HITCH</b>							
Lift capacity at the hooks (OECD)	kg	3500					
<b>FRONT PTO</b>							
Type	○ electrohydraulic multidisc clutch with modulated engagement						
<b>CAB</b>							
Clever Cab - 4-post cab with McCormick mechanical suspension system	●						
In-cab noise level	dB(A)	68					
EasyPilot with multifunction armrest	●						
DSM Data Screen Manager	● 12" touch screen monitor						
DSM Plus	○ 12" digital instrument cluster and 12" main touch screen monitor						
<b>ON-BOARD TECHNOLOGY</b>							
PSM Precision Steering Management, rear ISOBUS and EazySteer	○ EGNOS full kit (20 cm precision) - ○ RTK NTRIP full kit ( 2 cm precision)						
McCormick Fleet & Remote Diagnostics Management - ready	●						
McCormick Fleet & Remote Diagnostics Management and McCormick Farm Pro Pack	on selected markets - ● 1 year - ○ 3 years - ○ 5 years						
<b>WEIGHTS AND DIMENSIONS</b>							
Wheelbase	mm	2651	2760	2651	2760		
Shipping weight - measured with average specs	kg	6400	6700	6700	7000		
Gross vehicle weight	kg	11500					
Max front and rear tyre sizes - (Index Radius - IR)	mm	600/60R28 (IR 675) - 710/60R38 (IR 875)					

<b>X7 SWB EFFICIENT</b>		<b>X7.417</b> P6-DRIVE	<b>X7.418</b> P6-DRIVE	<b>X7.617</b> P6-DRIVE	<b>X7.618</b> P6-DRIVE
<b>ENGINE</b>					
Max power (ISO TR 14396)	hp / kW	155 / 114	165 / 122	155 / 114	165 / 122
Max power with EPM (ISO TR 14396)	hp / kW	165 / 122	175 / 129	165 / 122	175 / 129
Max torque without EPM (with EPM) at 1400 rpm	Nm	652 (676)	700 (700)	652 (676)	694 (737)
Manufacturer - Engine type - Installation		FPT - N45 - structural engine		FPT - N67 - structural engine	
Stage V - Tier 4 Final exhaust after-treatment system		HI-eSCR2			
Cylinders - Displacement - Valves		4 / 4.51 / 16		6 / 6.71 / 24	
<b>TRANSMISSION</b>					
Type		P6-Drive - 6 powershift speeds and 5 robotized ranges			
No. of gears		● 30 F + 15 R without creeper - ○ 54 F + 27 R with creeper			
Transmission control		EasyPilot on RH console			
APS - Auto PowerShift		● electronically-controlled automatic powershift and range shifting			
<b>REAR PTO</b>					
Speeds		540 / 540 E / 1000 / 1000 E			
<b>FRONT AND REAR AXLES</b>					
Front suspended axle		○ IFS - independent front wheel suspension system			
<b>HYDRAULIC SYSTEM</b>					
Hydraulic piston pump with CCLS system - flow rate		● 123 l/min			
Remote valves - type, flow rate, min - max		● 3 mechanical, 80 l/min - ○ 3 mechanical + 1 electrohydraulic - ○ 3 mechanical + 2 electrohydraulic			
<b>REAR 3-POINT HITCH</b>					
Max lift capacity at the hooks - ram diameter	kg	● 6400 - 80 mm - ○ 9300 - 100 mm			
<b>FRONT 3-POINT HITCH</b>					
Lift capacity at the hooks (OECD)	kg	3500			
<b>FRONT PTO</b>					
Type		○ electrohydraulic multidisc clutch with modulated engagement			
<b>CAB</b>					
Première Cab - 4-post cab		●			
McCormick mechanical cab suspension system		○			
In-cab noise level		70			
EasyPilot on RH console		●			
<b>ON-BOARD TECHNOLOGY</b>					
McCormick Fleet & Remote Diagnostics Management - ready		●			
McCormick Fleet & Remote Diagnostics Management and McCormick Farm Pro Pack		on selected markets - ● 1 year - ○ 3 years - ○ 5 years			
<b>WEIGHTS AND DIMENSIONS</b>					
Wheelbase	mm	2651		2760	
Shipping weight - measured with average specs	kg	6400		6700	
Gross vehicle weight	kg	11500			
Max front and rear tyre sizes - (Index Radius - IR)		600/60R28 (IR 675) - 710/60R38 (IR 875)			

<b>X6.6</b>		<b>X6.616</b> XTRASHIFT	<b>X6.618</b> XTRASHIFT
<b>ENGINE</b>			
Max power (97/68/EC - ISO TR 14396)	hp / kW	155 / 114	166 / 122
Max power with EPM (97/68/EC - ISO TR 14396)	hp / kW	165 / 122	175 / 129
Max torque without EPM (with EPM) at 1400 rpm	Nm	652 (676)	700 (700)
Manufacturer		FPT	
Engine type - Installation		NEF 67 - structural engine	
Stage V / Tier 4 Final exhaust after-treatment system		HI-eSCR2	
Cylinders / Displacement / Valves		6 / 6.71 / 24	
<b>TRANSMISSION</b>			
Type		XtraShift - 6 speeds (HML) and 3 ranges	
No. of gears		● 54 F + 18 R without creeper - ○ 105 F + 36 R with creeper	
Transmission & other controls		powershift controlled by switches - gears & ranges controlled by levers	
<b>REAR PTO</b>			
Speeds		540 / 1000	
<b>HYDRAULIC SYSTEM</b>			
Hydraulic piston pump with CCLS system - flow rate		● - 110 l/min	
Remote valves - type, flow rate, min - max		● 3 mechanical - ○ 5 mechanical, 80 l/min	
<b>REAR 3-POINT HITCH</b>			
Max lift capacity at the hooks - ram diameter	kg	● 8400 - 100 mm	
<b>FRONT 3-POINT HITCH</b>			
Lift capacity at the hooks (OECD at the hooks)	kg	~	
<b>FRONT PTO</b>			
Type		~	
<b>CAB</b>			
McCormick mechanical cab suspension system		~	
Instrument cluster with digital display		● controlled by switches	
<b>WEIGHTS AND DIMENSIONS</b>			
Wheelbase	mm	2880	
Shipping weight - measured with average specs	kg	6700	
Gross vehicle weight	kg	11300	
Max front and rear tyre sizes - (Index Radius - IR)	mm	540/65R28 (IR 675) - 650/65R38 (IR 875)	

X6.4	X6.413 P6-DRIVE	X6.414 P6-DRIVE	X6.415 P6-DRIVE
<b>ENGINE</b>			
Max power (97/68/EC - ISO TR 14396)	hp / kW	125.1/92,0	135.3/99.5
Max power with EPM (97/68/EC - ISO TR 14396)	hp / kW	135.3/99.5	14.6/107.1
Max torque without EPM (with EPM) at 1400 rpm	Nm	520 (551)	551 (610)
Manufacturer		FPT	
Engine type - Installation		NEF 45	
Stage V / Tier 4 Final exhaust after-treatment system		HI-eSCR2	
Cylinders / Displacement / Valves		4 / 4.5 l / 16	
<b>CAPACITIES</b>			
Fuel tank	l		220
<b>TRANSMISSION</b>			
Type		P6-Drive - 6 powershift and 4 synchronised ranges controlled by lever	
No. of gears		● 24 F + 24 R without creeper - ○ 40 F + 40 R with creeper	
Transmission & other controls		○ SmartPilot Plus with multifunction armrest - powershift, RPS, engine memo switch, MyHMF, rear PTO, rear remotes, front hitch & front loader controls	
<b>REAR PTO</b>			
Speeds		● 540 / 540 E - ○ 540 / 1000 - ○ 540 / 540 E / 1000 / 1000 E	
<b>FRONT AND REAR AXLES</b>			
Front suspended axle		○ IFS - independent front wheel suspension system with brakes	
<b>HYDRAULIC SYSTEM</b>			
Hydraulic piston pump with CCLS system - flow rate		● - 114 l/min	
Remote valves - type, flow rate, min - max		● 3 mechanical - 80 l/min - ○ 3 mechanical + 2 electrohydraulic, 5 electrohydraulic - 100 l/min	
Flow divider with flow selector - section flow rate		○ flow divider with 2 sections - 60l/min	
Free-flow return		●	
<b>REAR 3-POINT HITCH</b>			
Max lift capacity at the hooks - ram diameter	kg	● 7200 - 90 mm	
<b>FRONT 3-POINT HITCH</b>			
Lift capacity at the hooks (OECD at the hooks)	kg	2500	
<b>FRONT PTO</b>			
Type		○ electrohydraulic multidisc clutch with modulated engagement	
<b>CAB</b>			
McCormick High Vision cab - 4-post cab mounted on silent blocks		● with panoramic roof	
McCormick mechanical cab suspension system		○	
SmartPilot with armrest		●	
DSM Data Screen Manager		○ 12" touch screen monitor	
<b>ONBOARD TECHNOLOGY</b>			
PSM Precision Steering Management, rear ISOBUS & EazySteer - ready		○ ready - ○ EGNOS kit - ○ RTK NTRIP kit (AT spare parts)	
McCormick Fleet & Remote Diagnostics Management and McCormick Farm Pro Pack		(on selected markets) - ● 1 year - ○ 3 years - ○ 5 years	
<b>WEIGHTS AND DIMENSIONS</b>			
Wheelbase	mm	2560	
Shipping weight - measured with average specs	kg	5500	
Gross vehicle weight	kg	9500	
Max front and rear tyre sizes - (Index Radius - IR)	mm	520/60R28 VF (IR 650) - 650/60R38 VF (IR 825)	

Key: ● standard ○ option

X6	X6.125	X6.135
<b>ENGINE</b>		
Max power (97/68/EC - ISO TR 14396)	hp / kW	119 / 88
Max torque Engine speed at 1300 rpm	Nm	518
Manufacturer - Engine type		FPT F36
Cylinders / Displacement / Valves		4 / 3.6 l / 16V
<b>CAPACITIES</b>		
Fuel tank	l	170
<b>TRANSMISSION</b>		
No. of gears - std		● 36 F+12 R with XtraShift HML & RPS
No. of gears - with creeper		○ 48 F +16 R with XtraShift HML & RPS
Minimum speed	km/h	1.5 without creeper - 0.3 with creeper (IR 750mm)
Engine speed at 50 km/h	rpm	○ 2200
<b>REAR PTO</b>		
Speeds		● 540 / 540E / 1000 / 1000E with HML
<b>FRONT AND REAR AXLES</b>		
Front suspended axle		○
<b>BRAKING SYSTEM</b>		
Front braking system		● automatic 4WD engagement when braking - ○ with front brakes
<b>HYDRAULIC SYSTEM</b>		
Hydraulic piston pump with CCLS system - rear hitch & remotes + steering - flow rate	l/min	● 110 + 38
Rear spool valves type, flow rate, number		● mechanical, up to 3 - ○ mechanical up to 3 + electronic 2
<b>REAR 3-POINT HITCH</b>		
Rear hitch control		● electronic
Max lifting capacity at hitch points	kg	● 6000 with 2 assistor rams
<b>FRONT 3-POINT HITCH</b>		
Electronically-controlled front hitch	kg	○
<b>FRONT PTO</b>		
Type - Speed		○ electrohydraulic multidisc clutch with modulated engagement - 1000
<b>CAB</b>		
Total View Slim cab mounted on silent blocks		●
McCormick mechanical suspension		○
Heating/Climate control		● heating and ventilation - ○ manual climate control
Comfort air suspension seat		○
<b>ONBOARD TECHNOLOGY</b>		
PSM Precision Steering Management and ISOBUS		○ ready - ○ EGNOS with AES-35 Topcon steering wheel & X25 8.4" touch screen and AGS-2 aerial - ○ RTK NTRIP (AT spare parts)
McCormick Fleet & Remote Diagnostics Management and McCormick Farm Pro Pack		(on selected markets) - ● 1 year - ○ 3 years - ○ 5 years
<b>WEIGHTS AND DIMENSIONS</b>		
Wheelbase	mm	2420
Shipping weight - measured with average specs	kg	4800
Gross vehicle weight	kg	8500 (wide front axle) - 8000 (narrow front axle)
Max front and rear tyres sizes - (Index Radius -IR)	mm	480/65R24 - 540/65R38 (IR 800mm)

Key: ● standard ○ option

X5		X5.100	X5.110	X5.120
<b>ENGINE</b>				
Max power (97/68/EC - ISO TR 14396)	hp / kW	95/70	102/75	114/84
Max torque at 1400 rpm	Nm	395	430	460
Manufacturer		FPT		
Cylinders / Displacement / Valves		4 / 3.61 / 16		
<b>TRANSMISSION</b>				
No. of gears		● 12 F + 12 R with synchro shuttle (EFFICIENT) - ● 12 F + 12 R with RPS with modulation control (PREMIUM) ○ 24 F + 24 R with Hi-Lo powershift (EFFICIENT) - ○ 36 F +12 R with P3-Drive and RPS (PREMIUM)		
<b>REAR PTO</b>				
Speeds		● 540 - 540 / 540E - 540 / 1000 (EFFICIENT) - ● 540 / 540E - ○ 540 / 1000 ○ 540 / 540E / 1000 / 1000E with HML (PREMIUM)		
<b>FRONT AXLES</b>				
Front rigid axle		● (EFFICIENT-PREMIUM)		
Front suspended axle		○ (PREMIUM)		
<b>HYDRAULIC SYSTEM</b>				
Hydraulic pump for rear hitch and remote valves + steering - flow rate		● 62 + 32 l/min (EFFICIENT-PREMIUM) - ○ 82 + 32 l/min (PREMIUM)		
<b>REAR 3-POINT HITCH</b>				
Max lifting capacity at hitch points	kg	○ 4500 (EFFICIENT) - ● 4500 (PREMIUM) with 2 assistor rams		
<b>FRONT 3-POINT HITCH</b>				
Max lifting capacity at hitch points	kg	2200		
<b>FRONT PTO</b>				
Type - Speed		○ electrohydraulic multidisc clutch with modulated engagement - 1000 rpm		
<b>CAB</b>				
McCormick mechanical cab suspension		○ PREMIUM		
Platform version		○		
<b>ONBOARD TECHNOLOGY</b>				
Advanced Driving System		○ - ADS+, PSM ready with EazySteer		
PSM Precision Steering Management, ISOBUS		○ ready ○ - EGNOS with AES-35 Topcon steering wheel & X25 8.4" touch screen and AGS-2 aerial ○ - RTK NTRIP (AT spare parts)		
McCormick Fleet & Remote Diagnostics Management and McCormick Farm Pro Pack		(on selected markets) - ● 1 year - ○ 3 years - ○ 5 years		
<b>WEIGHTS AND DIMENSIONS</b>				
Wheelbase	mm	2355		
Standard weight measured with average specs	kg	4000		
Gross vehicle weight	kg	7000		

Key: ● standard ○ option

X5.085		X5.085
<b>ENGINE</b>		
Max power (97/68/EC - ISO TR 14396)	hp/kW	75 / 56
Max torque at 1400 rpm	Nm	375
Torque backup		56%
Manufacturer		FPT
Cylinders / Displacement / Valves		4 / 3.41 / 8
<b>TRANSMISSION</b>		
No. of gears		● 12F + 12R with synchro shuttle or RPS with modulation control ○ 24F + 24R with RPS with modulation control & Hi-Lo - ○ 36F + 12R, P3-Drive, RPS with modulation control
<b>REAR PTO</b>		
Speeds	rpm	● 540/540E - ○ 540/1000 - ○ 540/540E/1000/1000E - ○ 540
<b>FRONT AXLES</b>		
Front rigid axle		●
Front differential lock		● limited slip - ○ Hydralock full differential lock
<b>HYDRAULIC SYSTEM</b>		
Hydraulic pump for rear hitch & remote valves + steering - flow rate		● 56 + 30 l/min
<b>REAR 3-POINT HITCH</b>		
Max lifting capacity at hitch points	kg	● 3900
<b>FRONT 3-POINT HITCH</b>		
Max lifting capacity at hitch points	kg	1600
<b>FRONT PTO</b>		
Type		○ electrohydraulic multidisc clutch with modulated engagement
<b>CAB</b>		
Total View Slim cab mounted on silent blocks		●
<b>ONBOARD TECHNOLOGY</b>		
Socket ISO 11786		○
PSM Precision Steering Management		○ ready - ○ EGNOS with AES-35 Topcon steering wheel & X25 8.4" touch screen and AGS-2 aerial - ○ RTK NTRIP (AT spare parts)
McCormick Fleet & Remote Diagnostics Management and McCormick Farm Pro Pack		(on selected markets) - ● 1 year - ○ 3 years - ○ 5 years
<b>WEIGHTS AND DIMENSIONS</b>		
Wheelbase	mm	2171
Standard weight measured with average specs	kg	3700
Gross vehicle weight	kg	5800

Key: ● standard ○ option

X4		X4.060	X4.070	X4.080
<b>ENGINE</b>				
Max power (97/68/EC - ISO TR 14396)	hp / kW	61 / 45	68 / 50	75 / 55
Max torque at 1400 rpm - Stage V (Tier 4 Final)	Nm	285 (279)	310 (299)	310 (299)
Torque backup - Stage V (Tier 4 Final)		46% (43%)	43% (38%)	30% (25%)
Manufacturer		KOHLER		
Cylinders / Displacement / Valves		4 / 2.5 l / 16		
Maintenance interval		500 hours		
<b>TRANSMISSION</b>				
No. of gears		● 24F + 24R with synchro shuttle - ○ 12F + 12R with RPS		
<b>REAR PTO</b>				
Speeds	rpm	● 540/540E		
<b>FRONT AND REAR AXLES</b>				
Front rigid axle		●		
<b>HYDRAULIC SYSTEM</b>				
Hydraulic pump for rear hitch & remote valves + steering - flow rate		● 52 + 30 l/min		
<b>REAR 3-POINT HITCH</b>				
Max lifting capacity at hitch points	kg	● 3000		
<b>FRONT 3-POINT HITCH</b>				
Front hitch		*		
<b>FRONT PTO</b>				
Type - Speed		*		
<b>CAB</b>				
Total View Slim cab mounted on silent blocks		●		
Platform version		○		
<b>ONBOARD TECHNOLOGY</b>				
McCormick Fleet Management - ready		●		
McCormick Farm Start Pack		○ - 1 year, on selected markets		
McCormick Fleet & Remote Diagnostics Management and McCormick Farm Pro Pack		○ - on selected markets		
<b>WEIGHTS AND DIMENSIONS</b>				
Wheelbase	mm	2110		
Standard weight measured with average specs	kg	3200 cab - 3050 plat		
Gross vehicle weight	kg	5100		

Key: ● standard ○ option

X4T		X4.085 TF/TM	X4.095 TF/TM	X4.105 TF/TM	X4.110 TF/TM	X4.120 TF/TM
<b>ENGINE</b>						
Engine manufacturer		Deutz AG				
Engine type		TCD 2.9 L4 HT	TCD 2.9 L4 HP			
Max power (ISO)	hp/kW	75 / 56	90 / 66	95 / 70	102 / 75	112 / 82
Max torque	Nm	375	378	400	410	420
Displacement	cm <sup>3</sup>	2900				
Cylinders / Valves		4 TA / 8				
Emissions category		Stage V				
Fuel tank capacity	l	85				
<b>TRANSMISSION</b>						
Type		Speed Four				
No. of gears F + R		● 16+8 with Hi-Lo overdrive - ○ 16+8 w/creeper				
<b>REAR PTO</b>						
Type		servoassisted clutch				
Speeds	rpm	● 540-540E - ○ 540-1000				
<b>STEERING AND BRAKING SYSTEM</b>						
Steering system		hydrostatic Hi-Drive				
Steering control		2 levers operating 2 independent wet clutches and brakes				
Braking system		hydrostatic wet multidisc graphite brakes				
<b>HYDRAULIC SYSTEM</b>						
Hydraulic flow rate for rear hitch & remote valves + steering	l/min	42+28				
Rear remote valves		● 3 - ○ 4 / 5				
<b>REAR HYDRAULIC HITCH</b>						
Type		mechanical with position/draft/mixed/float control				
Max lifting capacity at hitch points	kg	● 2650 - ○ 4500 (w/assistor rams)				
<b>CAB AND DRIVING POSITION</b>						
Cab type		high-visibility 6-post monocoque cab w/flat floor and opening front/rear windows				
Cab suspension		● suspended on Hydro silent blocks				
Cab air filter - Filtration category		● dust filter - Cat.2				
Platform type		ROPS w/central tunnel, side gears and reverse shuttle controls				
Platform suspension		suspended on silent blocks w/air suspension seat				
Digital dashboard		●				
<b>WEIGHTS AND DIMENSIONS</b>						
Min-max overall width	mm	1410-1492 (metal TF) -1532 (rubber TF) / 1700-1750 (TM)				
Shipping weight	kg	3900 (TF) - 4500 (TM)				
<b>TRACKS</b>						
Track frame rollers		5 selead and lubricated rollers				
Track shoe type		● metal - ○ rubber				
Track shoe width	mm	310-360 (metal TF) / 400-450 (metal TM) / 400 (rubber TF/TM)				

Key: ● standard ○ option



X5 HC		X5.100 HC	X5.110 HC
<b>ENGINE</b>			
Max power (97/68/EC - ISO TR 14396)	hp / kW	95.2/70	102/75
Max torque at 1400 rpm	Nm	395	430
Manufacturer	FPT		
Cylinders / Displacement / Valves	4 / 3.6 l / 16		
<b>TRANSMISSION</b>			
No. of gears	● 12 F + 12 R with synchro shuttle - 4WD - ○ 24 F + 24R with Hi-Lo powershift		
<b>REAR PTO</b>			
Speeds	● 540 - ○ 540 / 540E - ○ 540 / 1000		
<b>FRONT AXLE</b>			
Front rigid axle	●		
<b>HYDRAULIC SYSTEM</b>			
Hydraulic pump for rear hitch & remotes + steering - flow rate	● 62 + 32 l/min		
<b>REAR 3-POINT HITCH</b>			
Max lifting capacity at hitch points	kg	○ 3900 with 2 assistor rams	
<b>CAB</b>			
Total View Slim cab mounted on silent blocks	●		
<b>ONBOARD TECHNOLOGY</b>			
McCormick Fleet Management - ready	●		
<b>WEIGHTS AND DIMENSIONS</b>			
Wheelbase	mm	2355	
Standard weight measured with average specs		4300 (4WD)	
Gross vehicle weight	kg	6000	

X4F CAB		X4.080 F-N-V-XL	X4.090 F-N-V-XL	X4.100 F-N-V-XL	X4.110 F-N-V-XL	X4.120 F-N-V-XL
<b>ENGINE</b>						
Engine manufacturer	Deutz AG					
Engine type	TCD 2.9 L4 HT	TCD 2.9 L4 HP				
Rated power (ISO)	hp/kW	75 / 56	78 / 58	85 / 63	95 / 70	104 / 77
Max power (ISO)	hp/kW	75 / 56	90 / 66	95 / 70	102 / 75	112 / 82
Max torque	Nm	375	378	400	410	420
Displacement	cm <sup>3</sup>	2900				
Cylinders / Valves	4 TA / 8					
Emissions category	Stage V / Tier IV					
After-treatment system	EGR + DOC + DPF	EGR + DOC + DPF + SCR				
<b>TRANSMISSION</b>						
Transmission type	● Speed Four - ○ Power Four (HiLo) / P6-Drive (HML)					
No. of gears F + R	○ 16+16 creeper / 32+32 Hi-Lo+creeper / 48+16 HML+creeper					
ECO engine speed at 40 km/h	○ 1750 (w/Hi-Lo/HML)					
Transmission control	● manual (Speed Four / Power Four / Xtrashift) - ○ robotised with multifunction joystick (P6-Drive)					
Front axle	● rigid - ○ suspended (F-N-XL)					
Traction type	fully electrohydraulic 4WD					
<b>REAR PTO</b>						
Type	● servoassisted clutch - ○ electrohydraulic multidisc clutch (w/RPS)					
Speeds	rpm	● 540-540E - ○ 540-1000 / 540-540E-1000-1000E / ground speed PTO				
<b>HYDRAULIC SYSTEM</b>						
Hydraulic pump for rear hitch & remotes + steering - flow rate	l/min	● 58+30 - ○ 30+58+36 (88 available for front and rear hitch & remotes)				
Rear remote valves	● 2 mechanical - ○ 3 mechanical / 3 mechanical + 1 electrohydraulic / 4 electrohydraulic					
Mid-mounted remote valves	○ 1 electrohydraulic / 3 electrohydraulic					
Front quick couplings	○ 2 + 1 free flow return / 4 + 2 free flow return / 6 + 1 or 2 free flow return / 8 + 2 free flow return					
<b>REAR HYDRAULIC HITCH</b>						
Type	● mechanical with position/draft/mixed control - ○ electronic with position/draft/mixed control					
Max lifting capacity at hitch points	kg	● 2700 - ○ 3400 (XL w/assistor rams)				
<b>FRONT HYDRAULIC HITCH</b>						
Type	○ electrohydraulic					
Max lifting capacity at hitch points	kg	1700 (F-N-XL) / 1400 (V)				
<b>FRONT PTO</b>						
Type	○ electrohydraulic multidisc clutch with modulated engagement					
<b>CAB AND DRIVING POSITION</b>						
Cab type	high-visibility 4-post monocoque cab w/flat floor and opening front/rear windows					
Cab suspension	● suspended on hydro silent blocks ○ mechanical spring suspension					
Cab air filter - Filtration category	● dust filter - Cat.2 - ○ active carbon filter - Cat.4					
<b>WEIGHTS AND DIMENSIONS</b>						
Wheelbase	mm	2140 (F-N-XL) / 2190 (V)				
Height from top of cab to rear axle centre	mm	1875 (Cat.2) / 1930 (Cat.4)				
Shipping weight	kg	2900 - 3250 (XL)				

X4F PLAT		X4.080 F-GE-GB-XL	X4.090 F-GE-GB-XL	X4.100 F-GE-GB-XL	X4.110 F-GE-GB-XL	X4.120 F-GE-GB-XL
<b>ENGINE</b>						
Engine manufacturer	Deutz AG					
Engine type	TCD 2.9 L4 HT	TCD 2.9 L4 HP				
Rated power (ISO)	hp/kW	75 / 56	78 / 58	85 / 63	95 / 70	104 / 77
Max power (ISO)	hp/kW	75 / 56	90 / 66	95 / 70	102 / 75	112 / 82
Max torque	Nm	375	378	400	410	420
Displacement	cm <sup>3</sup>	2900				
Cylinders / Valves	4 TA / 8					
Emissions category	Stage V / Tier IV					
After-treatment system	EGR + DOC + DPF	EGR + DOC + DPF + SCR				
<b>TRANSMISSION</b>						
Transmission type	● Speed Four - ○ Speed Four (Hi-Lo) / Power Four (Hi-Lo) / Xtrashift (HML)					
No. of gears F + R	● 12+12 - ○ 16+16 creeper / 24+24 Hi-Lo / 32+32 Hi-Lo+creeper / 36+12 HML / 48+16 HML+creeper					
ECO engine speed at 40 km/h	○ 1750 (with Hi-Lo/HML)					
Transmission control	● manual (Speed Four / Power Four / Xtrashift)					
Front axle	● rigid - ○ suspended (F-XL)					
Traction type	fully electrohydraulic 4WD					
<b>REAR PTO</b>						
Type	● servoassisted clutch - ○ electrohydraulic multidisc clutch (w/RPS)					
Speeds	rpm	● 540-540E - ○ 540-1000 / 540-540E-1000-1000E / ground speed PTO				
<b>HYDRAULIC SYSTEM</b>						
Hydraulic pump for rear hitch & remotes + steering - flow rate	l/min	● 58+30 - ○ 30+58+36 (88 available for front and rear hitch & remotes)				
Rear remote valves	● 2 mechanical - ○ 3mechanical / 3 mechanical + 1 electrohydraulic					
Mid-mounted remote valves	○ 1 electrohydraulic / 3 electrohydraulic					
Front quick couplings	○ 2 + 1 free flow return / 4 + 1 free flow return					
<b>REAR HYDRAULIC HITCH</b>						
Type	● mechanical with position/draft/mixed control - ○ electronic with position/draft/mixed control					
Max lift capacity at hitch points	kg	● 2700 - ○ 3400 (XL w/assistor rams)				
<b>FRONT HYDRAULIC HITCH</b>						
Type	○ electrohydraulic (F-GE-XL)					
Max lift capacity at hitch points	kg	1700				
<b>FRONT PTO</b>						
Type	○ electrohydraulic multidisc clutch with modulated engagement					
<b>DRIVING POSITION</b>						
Platform type	● ROPS with 228 mm high central tunnel					
Platform suspension	suspended on silent blocks					
<b>WEIGHTS AND DIMENSIONS</b>						
Wheelbase	mm	2140				
Height from top of ROPS to rear axle centre	mm	1840				
Shipping weight	kg	2800				

X3		X3.070 F-GE	X3.080 F-GE
<b>ENGINE</b>			
Engine manufacturer	Kohler		
Engine type	KDI 2504 TCR		
Max power (ISO)	hp/kW	68 / 50	75 / 55
Rated engine speed	rpm	2200	
Max torque	Nm	315	
Max torque engine speed	rpm	1500	
Displacement	cm <sup>3</sup>	2500	
Cylinders / Valves	4 TA / 16		
Emissions category	Stage V		
Fuel tank capacity	l	50	
<b>TRANSMISSION</b>			
No. of gears F+R	● 12+12 - ○ 16+16 w/creeper		
ECO engine speed at 40 km/h	rpm	● 2200	
Traction type	electrohydraulic 4WD		
Front differential lock	● Hydralock		
<b>REAR PTO</b>			
Speeds	rpm	● 540 - ○ 540-540E / 540-1000 /ground speed PTO	
<b>HYDRAULIC SYSTEM</b>			
Hydraulic flow rate for rear hitch & remote valves + steering	l/min	● 50+30	
Rear remote valves	● 1 - ○ 2 / 3		
Rear hitch category - coupler type	Cat.2 w/quick hooks		
Max lifting capacity at hitch points	kg	● 2200 - ○ 2700 w/heavy-duty hitch and ELS	
<b>CAB AND DRIVING POSITION</b>			
Cab type	● low-profile 6-post cab w/central tunnel (F-GE) - ○ high visibility 4-post monocoque cab		
Platform type	● ROPS with 265mm high central tunnel		
<b>WEIGHTS AND DIMENSIONS</b>			
Wheelbase	mm	1950	
Height from top of ROPS to rear axle centre	mm	1965	
Height from top of cab to rear axle centre	mm	1500 (LP Cab) / 1660 (STD Cab Cat.2) / 1695 (STD Cab Cat.4)	
Height from top of bonnet to rear axle centre	mm	755	
Max length w/front weights	mm	3652	
Min-max overall width	mm	360-1710 (F) / 1425-1710 (GE)	
Shipping weight	kg	2200 (Plat) / 2500 (LP Cab) / 2500 (STD Cab)	
Front and mid-mount implement support	○		

# TECHNICAL DATA

X2		X2.055 STD	X2.060 STD	X2.055 GE	X2.060 GE
<b>ENGINE</b>					
Engine manufacturer		Kohler			
Engine type		KDI1903 TCR			
Max power (ISO)	hp/kW	49 / 36	57 / 42	49 / 36	57 / 42
Max torque	Nm	180	200	180	200
Max torque engine speed	rpm	1200			
Displacement	cm <sup>3</sup>	1900			
Cylinders / Valves		3 TA / 12			
Emissions category		Stage V			
After-treatment system		EGR + DOC + DPF			
Engine Memo Switch		●			
<b>TRANSMISSION</b>					
Transmission type		mechanical			
No. of gears F + R		● 12+12 - ○ 16+16 w/creeper			
Reverse shuttle		synchro shuttle			
Traction type		4WD			
<b>REAR PTO</b>					
Speeds	rpm	● 540/540E ground speed PTO			
<b>HYDRAULIC SYSTEM</b>					
Hydraulic flow rate for rear hitch & remotes + steering	l/min	35+20			
Rear remote valves		● 2 std - ○ 2 std + 1 with float position			
<b>REAR HYDRAULIC HITCH</b>					
Hitch type		mechanical with position and draft control			
Max lifting capacity at hitch points	kg	1200			
<b>FRONT HYDRAULIC HITCH</b>					
Max lifting capacity at hitch points	kg	400			
<b>CAB AND DRIVING POSITION</b>					
Cab type		○ 4-post FOPS structure w/opening front window		~	
Cab air conditioning		○ manual A/C		~	
Digital dashboard		●			
<b>WEIGHTS AND DIMENSIONS</b>					
Wheelbase	mm	1790		1770	
Min-max height over bonnet	mm	1230 - 1305		1131 - 1206	
Min-max length w/front weights	mm	3168 - 3504		3168 - 3504	
Min rear tyre size - Index Radius - IR	mm	320/70R20 - 475		320/70R20 - 475	
Shipping weight	kg	1600 / 1780		1580	

Key: ● standard ○ option ~ not available





**Power Technology.**

via G. Matteotti, 7 | 42042 Fabbro [RE] Italia | t. +39.0522.656.111 | f. +39.0522.656.476  
webmaster@argotractors.com | www.argotractors.com



graphic design: gruppo saldatori | [www.grupposaldatori.com](http://www.grupposaldatori.com)  
All data and illustrations provided in this brochure are for information purposes only and can be changed without notice.

**EN**  
**6737433A2**